

# CATALOGUE

# 2024

*Paint spraying components and accessories*





## SPRAYING TECHNOLOGY

**A dynamic company,  
constantly growing and  
with an eye on the future**

---

Berizzi is an **Italian company** producing **components and accessories for paint spraying and fluid handling** with high quality standards at highly competitive prices in the market.

The company was established as Filtermedia in 1996 in Calolziocorte, Northern Italy. In 2020 Filtermedia became Berizzi, maintaining the same ownership and headquarters as well as its productive and organizational characteristics.

Today, it is one of the leading European manufacturers of high quality **“Made in Italy”** parts and components for fluid handling, owning a 5,500 sqm production site.

Since some years ago, Berizzi has started a procedure of **corporate certification** according to the main international standards. All processes and services are in fact certified in accordance with the **UNI EN ISO 9001: 2015** standard, certification body accredited by ACCREDIA. For all products, Berizzi has acquired the most important certifications in the sector.





The company is based in Calolziocorte with its internal and “Made in Italy” production, in a strategic area on the shores of Lake Como, near Bergamo, Milan and the Brianza. It is divided into **5 departments**: turning, plastic molding, shearing of steel and iron components, cutting of nets for filters and welding. Berizzi also uses **quality control, assembly and shipping departments**, to conclude its production cycle.



## Advanced machinery



Berizzi employs cutting-edge **professional machinery** with a high level of **automation and precision**. It has specific machinery for turning: numerical control lathes (CNC) divided between multi-spindle and head-stock machine and milling machinery.

## The values of the company are:

### Reliability

Berizzi is a professional and reliable company. It offers its customers a complete, quick, punctual service in the agreed times and delivery methods. Its products are made with high quality materials, following the highest production standards.

### Quality

Berizzi seeks quality in every sphere, always at a competitive price on the market. From the careful selection of raw materials, to the creation of a certified and transparent supply chain, up to the improvement of production processes: each phase of the work remains in line with **the highest standards in the sector**.



### Customer orientation

Berizzi fulfills every client’s request quickly and efficiently. **Customer satisfaction is its priority**.

### “Made in Italy”

Since its establishment, Berizzi continues to bring all over the world high quality production and Italian standards, thanks to its presence in over 40 countries.

### Experience and Innovation

Berizzi is proud of its know-how, one of the main resources that makes it so competitive in the sector. The company constantly invests in R&D, qualified staff and production machinery.



## Product quality and prompt service

# TABLE OF CONTENTS



page  
6

**PUMPS**



page  
56

**MANUAL HIGH  
PRESSURE GUNS**



page  
68

**AUTOMATIC HIGH  
PRESSURE GUNS**



page  
140

**SPRAY GUN  
SPARE PARTS**



page  
166

**PUMPS SPARE  
PARTS**



page  
188

**FLUID  
REGULATORS**



page  
76

**PAINT SPRAYING  
SYSTEMS FOR  
INTERNAL PIPES  
COATING**



page  
80

**PAINT SPRAYING  
FILTERS**



page  
104

**SPRAY GUNS  
NOZZLES**



page  
192

**MIXING AND  
HEATING**



page  
206

**UNDER PRESSURE  
TANKS**



page  
212

**HOSES**



page  
120

**FILTER HOLDERS**



page  
126

**INLINE FILTERS**



page  
132

**GRAVITY TANKS**



page  
238

**FITTINGS**



page  
258

**SANDBLASTING**



page  
264

**LOW PRESSURE  
GUNS**

## PUMPS



Berizzi produces a wide range of **high and low-pressure pumps** for paint spraying and fluid handling of various types (pneumatic piston pumps, electric diaphragm pumps, hydraulic piston pumps and double diaphragm pumps) and for various industrial sectors (wood, metal, automotive, conditioning and hydraulics, shipbuilding, construction and heavy carpentry).

These products, designed and manufactured in-house, allow the company to satisfy all requests coming from an increasingly demanding market.

APOLLO	page 8
APOLLO TRANSFER	page 26
APOLLO EXTRUSION	page 32
TSUNAMI/ARES	page 36
MISTRAL	page 42
GEA	page 43
MIURA	page 46
B24	page 52



# APOLLO 303

**Piston pneumatic pump** for medium pressure professional air assisted-airless paint spraying, suitable for the wood and metal sectors.



CODE	DESCRIPTION
TKP303F	APOLLO 303 Pneumatic air-assisted airless pump C/ Trolley - Pressure regulation control plate - Stainless steel inline filter - Twin hose HP 7,5 m - Mach3 spray gun - Gravity tank with adapter

CODE	DESCRIPTION
TKP303E	APOLLO 303 Pneumatic air-assisted airless pump C/ Trolley - Pressure regulation control plate - Stainless steel inline filter - Suction system

CODE	DESCRIPTION
TKP303A	APOLLO 303 Pneumatic air-assisted airless pump C/ Trolley - Pressure regulation control plate - Stainless steel inline filter - Gravity tank with adapter

CODE	DESCRIPTION
TKP303C	APOLLO 303 Pneumatic air-assisted airless pump on bracket - Pressure regulator - Stainless steel inline filter

CODE	DESCRIPTION
TKP303G	APOLLO 303 Pneumatic air-assisted airless pump C/ Stainless steel inline filter

CODE	DESCRIPTION
TKP303B	APOLLO 303 Pneumatic air-assisted airless pump C/ Trolley - Pressure regulation control plate - Stainless steel inline filter - Twin hose HP 7,5 m - Mach3 spray gun - Suction system

		APOLLO 303
Ratio		30:1
Pump capacity per cycle	cm <sup>3</sup>	40
Stroke	mm	60
Max. Delivery free flow	ltr/min	4
Number of strokes per liter	Bar (PSI)	25
Max. Working outlet pressure	Bar (PSI)	240 (3480)
Max. Air inlet pressure	Bar (PSI)	8 (116)
Weight	kg.	14
Air consumption	ltr/min	250 - 400
Packing type		Fixed
Material inlet fitting size		M 3/4"
Material outlet fitting size		M 1/4"
Packing material		PTFE - PE

### APPLICATION

Suitable for low and medium viscosity varnish, lacquers, enamels and primer. All the components in the fluid section are in stainless steel and tungsten carbide, to always guarantee the best quality.

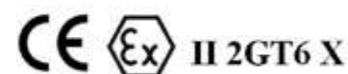

ACCESSORIES KIT	
TT1001	MACH 3 AIR-ASSISTED AIRLESS SPRAY GUN
6616750	HP TWIN HOSE 3/16" + 1/4" MT 7,5 1/4" CONN.
FM61000	WHITE 6L GRAVITY TANK
FM610061	"U" OBLIQUE ADAPTER M36x2mm X F3/4"

ACCESSORIES KIT	
TRK303P	REPAIR KIT GASKET PUMP
690349I	S.STEEL SUCTION SYSTEM Ø13 F 3/4" 90° M15x1.450mm
690349AK	FM60005 SUCTION HOUSING KIT F15x1mm
	RAP3040R7 RETURN HOSE Ø1/4" MT1.5 F1/4" CONN. ONE SIDE



# APOLLO 303R

**Inverted piston pneumatic pump** for medium pressure air assisted-airless paint spraying, suitable for the wood and metal sectors.



CODE	DESCRIPTION
TKP303H	APOLLO 303R Air-assisted airless inverted pump C/ Trolley - Pressure regulation control plate - Stainless steel inline filter - Twin hose 7,5m - Mach3 spray gun - Gravity tank

		APOLLO 303R
Ratio		30:1
Pump capacity per cycle	cm <sup>3</sup>	40
Stroke	mm	60
Max. Delivery free flow	ltr/min	4
Number of strokes per liter	Bar (PSI)	25
Max. Working outlet pressure	Bar (PSI)	240 (3480)
Max. Air inlet pressure	Bar (PSI)	8 (116)
Weight	kg.	14
Air consumption	ltr/min	250 - 400
Packing type		Fixed
Material inlet fitting size		M 3/4"
Material outlet fitting size		M 1/4"
Packing material		PTFE - PE

### APPLICATION

Suitable for low and medium viscosity varnish, lacquers, enamels and primer. All the components in the fluid section are in stainless steel and tungsten carbide, to always guarantee the best quality.

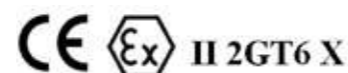

ACCESSORIES KIT	
TT1001	MACH 3 AIR-ASSISTED AIRLESS SPRAY GUN
6616750	HP TWIN HOSE 3/16" +1/4" MT 7,5 1/4" CONN.
FM61000	WHITE 6L GRAVITY TANK
FM610061	"U" OBLIQUE ADAPTER M36x2mm X F3/4"

ACCESSORIES KIT	
TRK303P	REPAIR KIT GASKET PUMP
690349I	S. STEEL SUCTION SYSTEM Ø13 F3/4" 90° M15x1450mm
690349AK	FM60005 SUCTION HOUSING KIT F15x1mm
RAP3040	R7 RETURN HOSE Ø1/4" MT1.5 F1/4" CONN. ONE SIDE

CODE	DESCRIPTION
TKP303D	APOLLO 303R Air-assisted airless inverted pump C/ Trolley - Pressure regulation control plate - Stainless steel inline filter - Gravity tank

CODE	DESCRIPTION
TKP303I	APOLLO 303R Air-assisted airless inverted pump on bracket - Pressure regulator - Stainless steel inline filter - Gravity tank

**AIR-ASSISTED  
AIRLESS**



# APOLLO 30

Piston pneumatic air-assisted airless pump for medium pressure professional paint spraying, suitable for the wood and metal sectors. Available in the airless model.

CODE	DESCRIPTION
TKB30G	APOLLO 30 Piston pneumatic air-assisted airless pump C/ Trolley - Pressure regulation control plate - Stainless steel inline filter - Twin hose HP 7,5 m - Mach3 spray gun - Complete suction system

		APOLLO 30
Ratio		30:1
Pump capacity per cycle	cm <sup>3</sup>	37
Stroke	mm	100
Max. Delivery free flow	ltr/min	7
Number of strokes per liter	Bar (PSI)	27
Max. Working outlet pressure	Bar (PSI)	240 (3480)
Max. Air inlet pressure	Bar (PSI)	8 (116)
Weight	kg.	27
Air consumption	ltr/min	250 - 750
Packing type		Fixed
Material inlet fitting size		M 3/4"
Material outlet fitting size		M 1/4"
Packing material		PTFE - PE

### APPLICATION

Suitable for low and medium viscosity varnish, lacquers, enamels and primers. All the components in the fluid section are in stainless steel and tungsten carbide, to always guarantee the best quality.



ACCESSORIES KIT	
TT1001	MACH 3 AIR-ASSISTED AIRLESS SPRAY GUN
6616750	HP TWIN HOSE 3/16" +1/4" MT 7,5 1/4" CONN.
FM61000	WHITE 6L GRAVITY TANK
FM610061	"U" OBLIQUE ADAPTER M36x2mmXF36x2mm

ACCESSORIES KIT	
TRK3001P	REPAIR KIT GASKET PUMP
69034912I	S.STEEL SUCTION SYSTEM Ø19F3/4" 90° M1/2" 750mm
69034912AK	FM60004 SUCTION HOUSING KIT F1/2"
RAP3040	R7 RETURNED HOSE Ø1/4" MT1.5 F1/4" CONN. ONE SIDE



CODE	DESCRIPTION
TKB30H	APOLLO 30 Piston pneumatic air-assisted airless pump C/ Trolley - Pressure regulation control plate - Stainless steel inline filter - Twin hose HP 7,5 m - Mach3 spray gun - Gravity tank with adapter

COD	DESCRIZIONE
TKB30E	APOLLO 30 Piston pneumatic air-assisted airless pump C/ Trolley - Pressure regulation control plate - Stainless steel inline filter - Complete suction system

CODE	DESCRIPTION
TKB30F	APOLLO 30 Piston pneumatic air-assisted airless pump C/ Trolley - Pressure regulation control plate - Stainless steel inline filter - Gravity tank with adapter

CODE	DESCRIPTION
TKB30I	APOLLO 30 Piston pneumatic air-assisted airless pump on bracket - Pressure regulator - Stainless steel inline filter

CODE	DESCRIPTION
TKB30C	APOLLO 30 Piston pneumatic air-assisted airless pump C/ Stainless steel inline filter



### AIRLESS



# APOLLO 30

Piston pneumatic airless pump for medium pressure professional paint spraying, suitable for the wood and metal sectors.  
Available in the air-assisted airless model.

CODE	DESCRIPTION
TKB30L	APOLLO 30 Piston pneumatic airless pump C/ Trolley - Pressure regulation control plate - Stainless steel inline filter - HP hose 7,5 m - RST1 spray gun - FM6 tip guard - Reversible FM6 tip - Complete suction system

		APOLLO 30
Ratio		30:1
Pump capacity per cycle	cm <sup>3</sup>	37
Stroke	mm	100
Max. Delivery free flow	ltr/min	7
Number of strokes per liter	Bar (PSI)	27
Max. Working outlet pressure	Bar (PSI)	240 (3480)
Max. Air inlet pressure	Bar (PSI)	8 (116)
Weight	kg.	27
Air consumption	ltr/min	250 - 750
Packing type		Fixed
Material inlet fitting size		M 3/4"
Material outlet fitting size		M 1/4"
Packing material		PTFE - PE

### APPLICATION

Suitable for low and medium viscosity varnish, lacquers, enamels and primers.  
All the components in the fluid section are in stainless steel and tungsten carbide, to always guarantee the best quality.

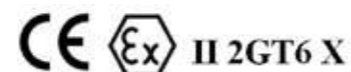

ACCESSORIES KIT	
RST11	HP RST1 SPRAY GUN 1/4" CONN.
614754	HP HOSE 1/4" MT 7,5 1/4" CONN.
201203	TIP GUARD FOR REVERSIBLE TIPS
FM6XXX	FM6XXX REVERSIBLE TIP
FM61000	WHITE 6L GRAVITY TANK

ACCESSORIES KIT	
FM610061	"U" OBLIQUE ADAPTER M36x2mm X F3/4"
TRK3001P	REPAIR KIT GASKET PUMP
69034912I	S.S. STEEL SUCTION SYSTEM Ø19 F3/4" 90° M1/2" 750mm
FM60004	SUCTION HOUSING KIT F1/2"
RAP3040R7	RETURNED HOSE Ø1/4" MT1.5 F1/4" CONN. ONE SIDE



CODE	DESCRIPTION
TKB30M	APOLLO 30 Piston pneumatic airless pump C/ Trolley - Pressure regulation control plate - Stainless steel inline filter - HP hose 7,5 m - RST1 spray gun - FM6 tip guard - Reversible FM6 tip - Gravity tank with adapter

CODE	DESCRIPTION
TKB30A	APOLLO 30 Piston pneumatic airless pump C/ Trolley - Pressure regulation control plate - Stainless steel inline filter - Complete suction system

CODE	DESCRIPTION
TKB30D	APOLLO 30 Piston pneumatic airless pump C/ Trolley - Pressure regulation control plate - Stainless steel inline filter - Gravity tank with adapter

CODE	DESCRIPTION
TKB30B	APOLLO 30 Piston pneumatic airless pump on bracket - Pressure regulation control plate - Stainless steel inline filter

CODE	DESCRIPTION
TKB30C	APOLLO 30 Piston pneumatic airless pump C/ Stainless steel inline filter

# PUMPS

## APOLLO | Piston Pneumatic Pumps

## APOLLO 40 AIR-ASSISTED AIRLESS | AVAILABLE MODELS

**AIR-ASSISTED  
AIRLESS**



# APOLLO 40

**Piston pneumatic air-assisted airless pump** for medium pressure professional paint spraying, suitable for the wood and metal sectors. Available in the airless model.

CODE	DESCRIPTION
TKP401AB	APOLLO 40 Piston pneumatic air-assisted airless pump C/ Trolley - Pressure regulation control plate - Stainless steel inline filter - Twin hose HP 7,5m - Mach3 spray gun - Complete suction system

		APOLLO 40
Ratio		40:1
Pump capacity per cycle	cm <sup>3</sup>	50
Stroke	mm	80
Max. Delivery free flow	ltr/min	9
Number of strokes per liter	Bar (PSI)	20
Max. Working outlet pressure	Bar (PSI)	320 (4640)
Max. Air inlet pressure	Bar (PSI)	8 (116)
Weight	kg.	32
Air consumption	ltr/min	250 - 1000
Packing type		Mobile
Material inlet fitting size		M 36x2 mm
Material outlet fitting size		M 1/4"
Packing material		PTFE-PE-LEATHER

### APPLICATION

Suitable for the wood and metal sectors with medium-high viscosity enamels, lacquers, base coats and varnishes, water-based or solvent. All the components in the fluid section are in stainless steel and tungsten carbide, to always guarantee the best quality.

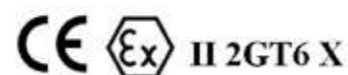

ACCESSORIES KIT	
TT1001	HP MACH 3 SPRAY GUN
6616750	HP TWIN HOSE 3/16" +1/4" MT 7,5 1/4 CONN.
FM61000	WHITE 6L GRAVITY TANK
FM610062	"U" OBLIQUE ADAPTER M36x2mm XF36x2mm

ACCESSORIES KIT	
TRK4010P	REPAIR KIT GASKET PUMP
69362912AK	69362912I S.STEEL SUCTION SYSTEM Ø19 F36x2 90° M1/2" 750mm
	FM60004 SUCTION HOUSING KIT F1/2"
	RAP3040 R7 RETURNED HOSE Ø1/4" MT 1.5 F1/4" CONN. ONE SIDE



CODE	DESCRIPTION
TKP401AC	APOLLO 40 Piston pneumatic air-assisted airless pump C/ Trolley - Pressure regulation control plate - Stainless steel inline filter - Twin hose HP 7,5m - Mach3 spray gun - Gravity tank with adapter



CODE	DESCRIPTION
TKP401AA	APOLLO 40 Piston pneumatic air-assisted airless pump C/ Trolley - Pressure regulation control plate - Stainless steel inline filter - Complete suction system



CODE	DESCRIPTION
TKP401AD	APOLLO 40 Piston pneumatic air-assisted airless pump C/ Trolley - Pressure regulation control plate - Stainless steel inline filter - Gravity tank with adapter



CODE	DESCRIPTION
TKP401AE	APOLLO 40 Piston pneumatic air-assisted airless pump on bracket - Pressure regulators - Stainless steel inline filter



CODE	DESCRIPTION
TKP401F	APOLLO 40 Piston pneumatic air-assisted airless pump C/ Stainless steel inline filter

### AIRLESS



# APOLLO 40

**Piston pneumatic airless pump** for medium pressure professional paint spraying, suitable for the wood and metal sectors.  
Available in the air-assisted airless model.

CODE	DESCRIPTION
TKP401B	APOLLO 40 Piston pneumatic airless pump C/ Trolley - Pressure regulation control plate - Stainless steel inline filter - HP hose 7,5m - RST2 spray gun - FM6 tip guard - Reversible FM6 tip - Complete suction system

		APOLLO 40
Ratio		40:1
Pump capacity per cycle	cm <sup>3</sup>	50
Stroke	mm	80
Max. Delivery free flow	ltr/min	9
Number of strokes per liter	Bar (PSI)	20
Max. Working outlet pressure	Bar (PSI)	320 (4640)
Max. Air inlet pressure	Bar (PSI)	8 (116)
Weight	kg.	32
Air consumption	ltr/min	250 - 1000
Packing type		Mobile
Material inlet fitting size		M 36x2 mm
Material outlet fitting size		M 1/4"
Packing material		PTFE-PE-LEATHER

### APPLICATION

Suitable for the wood and metal sectors with medium-high viscosity enamels, lacquers, base coats and varnishes, water-based or solvent. All the components in the fluid section are in stainless steel and tungsten carbide, to always guarantee the best quality.

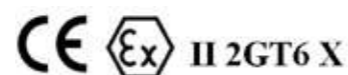

ACCESSORIES KIT	
RST21	HP RST2 SPRAY GUN 1/4" CONN.
614754	HP HOSE 1/4" MT 7,5 1/4" CONN.
201203	TIP GUARD FOR REVERSIBLE TIPS
FM6XXX	FM6XXX REVERSIBLE TIP
FM61000	WHITE 6L GRAVITY TANK

ACCESSORIES KIT	
FM610062	"U" OBLIQUE ADAPTER M36x2mmXF36x2mm
TRK4010P	REPAIR KIT GASKET PUMP
69034912I	S.STEEL SUCTION SYSTEM Ø19 F3/4" 90° M1/2" 750mm
69362912AK	FM60004 SUCTION HOUSING KIT F1/2"
	RAP3040 R7 RETURNED HOSE Ø1/4" MT1.5 F1/4" CONN. ONE SIDE



CODE	DESCRIPTION
TKP401D	APOLLO 40 Piston pneumatic airless pump C/ Trolley - Pressure regulation control plate - Stainless steel inline filter - HP hose 7,5m - RST2 spray gun - FM6 tip guard - Reversible FM6 tip - Gravity tank with adapter

CODE	DESCRIPTION
TKP401A	APOLLO 40 Piston pneumatic airless pump C/ Trolley - Pressure regulation control plate - Stainless steel inline filter - Complete suction system

CODE	DESCRIPTION
TKP401E	APOLLO 40 Piston pneumatic airless pump C/ Trolley - Pressure regulation control plate - Stainless steel inline filter - Gravity tank with adapter

CODE	DESCRIPTION
TKP401C	APOLLO 40 Piston pneumatic airless pump on bracket with pressure regulators - Stainless steel inline filter

CODE	DESCRIPTION
TKP401F	APOLLO 40 Piston pneumatic airless pump C/ Stainless steel inline filter



# APOLLO 40 Mix

Two component pneumatic airless piston pump for high pressure paint spraying, suitable for treating paint and anti-corrosion with high viscosity products.

CODE	DESCRIPTION
TK97995	APOLLO 40 Mix Two component pneumatic airless pump C/ Trolley - Pressure regulator - 2 Inline filters - 2 Complete suction systems - Static mixer  APOLLO 303 Piston pneumatic pump flushing pump - Pressure regulator - Complete suction system

		APOLLO 40 MIX
Ratio		40:1
Mixing ratio	cm <sup>3</sup>	1:1
Pump capacity per cycle	cm <sup>3</sup>	73
Stroke	mm	80
Max. Delivery free flow	ltr/min	9
Max. Working outlet pressure	Bar (PSI)	240 (3480)
Max. Air inlet pressure	Bar (PSI)	8 (116)
Weight	kg.	45
Air consumption	ltr/min	250 - 400
Packing type		Fixed
Material inlet fitting size		M 36x2 mm
Material outlet fitting size		M 16x1,5 mm
Packing material		PTFE-PE

### APPLICATION

Suitable for treating paint and anti-corrosion with high viscosity products. It can be used in the naval, civil and industrial construction sectors and heavy carpentry, with bicomponent products, paint, anti-corrosives, intumescent coatings, protective coatings and encapsulants (water-based and solvent), putties, ready-mix stucco, fillers and mural injection resins.

All the components in the fluid section are in stainless steel and tungsten carbide, to always guarantee the best quality.

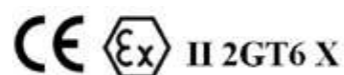

ACCESSORIES KIT	
RST21	HP RST2 SPRAY GUN 1/4" CONN.
614754	HP HOSE 1/4" MT 7,5 1/4" CONN.
201203	TIP GUARD FOR REVERSIBLE TIPS
FM6XXX	FM6XXX REVERSIBLE TIP
FM61000	WHITE 6 L GRAVITY TANK

ACCESSORIES KIT	
FM610062	"U" OBLIQUE ADAPTER M36x2mm X F36x2mm
TRK307P	REPAIR KIT GASKET PUMP
69362912AK	69362912I S. STEEL SUCTION HOSE Ø19 F3/4" 90° M1/2" 750mm
	FM60004 SUCTION HOUSING KIT F1/2"
	RAP3040R7 RETURNED HOSE Ø1/4" MT1.5 F1/4" CONN. ONE SIDE



CODE	DESCRIPTION
TKP40MIX	APOLLO 40 Mix Two component pneumatic airless pump C/ Trolley - Pressure regulator control plate - 2 Inline filters - 2 Complete suction systems - Static mixer



CODE	DESCRIPTION
TKP40MIXB	APOLLO 40 Mix Two component pneumatic airless pump C/ Trolley - Pressure regulator control plate - 2 Inline filters - 2 Gravity tanks with adapter - Static mixer



# APOLLO 48

Pneumatic airless piston pump for high pressure professional paint spraying, suitable for treating paint and anti-corrosion with high viscosity products.



CODE	DESCRIPTION
TKP4825C	APOLLO 48 Pneumatic airless piston pump C/ Trolley - Pressure regulator - Stainless steel inline filter - HP hose 10m - RST2 spray gun - FM6 tip guard - Reversible FM6 tip - Complete suction system

CODE	DESCRIPTION
TKP4825A	APOLLO 48 Pneumatic airless piston pump C/ Trolley - Pressure regulator - Stainless steel inline filter - Complete suction system

CODE	DESCRIPTION
TKP4825B	APOLLO 48 Pneumatic airless piston pump on bracket - Pressure regulator - Stainless steel inline filter

CODE	DESCRIPTION
TKP4825D	APOLLO 48 Pneumatic airless piston pump C/ Stainless steel inline filter

		APOLLO 48
Ratio		48:1
Pump capacity per cycle	cm <sup>3</sup>	143
Stroke	mm	100
Max. Delivery free flow	ltr/min	18
Number of strokes per liter	Bar (PSI)	7
Max. Working outlet pressure	Bar (PSI)	348 (5569)
Max. Air inlet pressure	Bar (PSI)	8 (116)
Weight	kg.	64
Air consumption	ltr/min	600 -2650
Packing type		Fixed
Material inlet fitting size		M 36x2 mm
Material outlet fitting size		M 16x1,5 mm
Packing material		PTFE-PE-LEATHER

### APPLICATION

Suitable for treating paint and anti-corrosion with high viscosity products. It can be used in the naval, civil and industrial construction sectors and heavy carpentry, with bicomponent products, paint, anti-corrosives, intumescent coatings, protective coatings and encapsulants (water-based and solvent), putties, ready-mix stucco, fillers and mural injection resins. All the components in the fluid section are in stainless steel and tungsten carbide, to always guarantee the best quality.

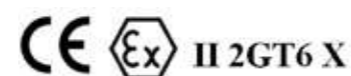

ACCESSORIES KIT	
RST22	HP RST2 SPRAY GUN 16x1,5mm CONN.
6381052	HP2 HOSE 3/8" MT.10 M16x1,5mm CONN.
201203	TIP GUARD FOR REVERSIBLE TIPS
FM6XXX	FM6XXX REVERSIBLE TIP

ACCESSORIES KIT	
TRK4825P	REPAIR KIT GASKET PUMP
68362951	S.STEEL SUCTION HOSE Ø25 F36x2 90° M28x1,5 120mm
6836295AK	S. STEEL SUCTION FILTER RACC F28x1,5mm 30M
RAP4860	R7 RETURNED HOSE Ø1/4" MT1.8 F1/4" CONN. ONE SIDE



# APOLLO 66

**Pneumatic airless piston pump** for high pressure professional paint spraying, suitable for treating paint and anti-corrosion with high viscosity products.

CODE	DESCRIPTION
TKP6618C	APOLLO 66 Pneumatic airless piston pump C/ Trolley - Pressure regulator - Stainless steel inline filter - HP hose 10m - RST2 spray gun - FM6 tip guard - Reversible FM6 tip - Complete suction system

		APOLLO 66
Ratio		66:1
Pump capacity per cycle	cm <sup>3</sup>	100
Stroke	mm	100
Max. Delivery free flow	ltr/min	15
Number of strokes per liter	Bar (PSI)	10
Max. Working outlet pressure	Bar (PSI)	528 (7657)
Max. Air inlet pressure	Bar (PSI)	8 (116)
Weight	kg.	64
Air consumption	ltr/min	600 -2650
Packing type		Fixed
Material inlet fitting size		M 36x2 mm
Material outlet fitting size		M 16x1,5 mm
Packing material		PTFE-PE-LEATHER

### APPLICATION

Suitable for treating paint and anti-corrosion with high viscosity products. It can be used in the naval, civil and industrial construction sectors and heavy carpentry, with bicomponent products, paint, anti-corrosives, intumescent coatings, protective coatings and encapsulants (water-based and solvent), putties, ready-mix stucco, fillers and mural injection resins. All the components in the fluid section are in stainless steel and tungsten carbide, to always guarantee the best quality.

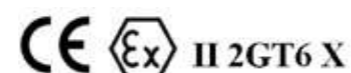

ACCESSORIES KIT	
RST22	HP RST2 SPRAY GUN 16x1,5mm CONN.
6381052	HP HOSE 3/8" MT.10 M16x1,5mm CONN.
201203	TIP GUARD FOR REVERSIBLE TIPS
FM6XXX	FM6XXX REVERSIBLE TIP

ACCESSORIES KIT	
TRK6618P	REPAIR KIT GASKET PUMP
6836295I	S.STEEL HOSE Ø25 F36x2mm 90° M28x1,5mm 1200mm
6836295AK	S. STEEL SUCTION FILTER F28x1,5 CONN. 30M
RAP4860	R7 RETURNED HOSE Ø1/4" MT1.8 F1/4" CONN. ONE SIDE



CODE	DESCRIPTION
TKP6618A	APOLLO 66 Pneumatic airless piston pump C/ Trolley - Pressure regulator - Stainless steel inline filter - Complete suction system



CODE	DESCRIPTION
TKP6618B	APOLLO 66 Pneumatic airless piston pump on bracket - Pressure regulator - Stainless steel inline filter



CODE	DESCRIPTION
TKP6618D	APOLLO 66 Pneumatic airless piston pump C/ Stainless steel inline filter



### APOLLO 303 Transfer

**Piston pneumatic transfer pump** suitable for rapid fluid handling in the naval, industrial and refinery sectors with paint, waste fluids, motor oil, gear oil, hydraulic fluid, oil and grease in general.



### APOLLO 30 Transfer

**Piston pneumatic transfer pump** suitable for rapid fluid handling in the naval, industrial and refinery sectors with paint, waste fluids, motor oil, gear oil, hydraulic fluid, oil and grease in general. Available with **3:1** and **6:1** ratio.

**3:1 RATIO**

CODE	DESCRIPTION
------	-------------

TKP1871A	APOLLO 303 Transfer 6:1 Piston pneumatic transfer pump on bracket - Pressure regulator - Complete suction system
----------	--

CODE	DESCRIPTION
------	-------------

TKP5031A	APOLLO 30 Transfer 3:1 Piston pneumatic transfer pump on bracket - Pressure regulator - Complete suction system
----------	---

		APOLLO 303
Ratio		6:1
Pump capacity per cycle	cm <sup>3</sup>	91
Stroke	mm	60
Max. Delivery free flow	ltr/min	16
Number of strokes per liter	Bar (PSI)	11
Max. Working outlet pressure	Bar (PSI)	48 (696)
Max. Air inlet pressure	Bar (PSI)	8 (116)
Weight	kg.	12
Air consumption	ltr/min	600 - 2650
Packing type		Fixed
Material inlet fitting size		M 3/4"
Material outlet fitting size		M 1/2"
Packing material		PTFE-PE

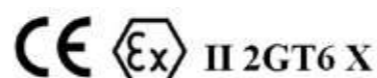

ACCESSORIES KIT	
TRK361P	REPAIR KIT GASKET PUMP
69034912I	S.STEEL SUCTION HOSE 19 F3/4" 90° M1/2" 750mm
69034912AK	FM60004 SUCTION HOUSING KIT F1/2"
RAP3040R7	RETURNED HOSE Ø1/4" MT1.5 F1/4" CONN ONE SIDE

		APOLLO 303:1
Ratio		3:1
Pump capacity per cycle	cm <sup>3</sup>	667
Stroke	mm	100
Max. Delivery free flow	ltr/min	42
Number of stroke per liter	Bar (PSI)	1.5
Max. Working outlet pressure	Bar (PSI)	24 (348)
Max. Air inlet pressure	kg.	8 (116)
Weight	kg.	18
Air consumption	ltr/min	600 - 2650
Packing type		Mobile
Material inlet fitting size		M 3/6x2 mm
Material outlet fitting size		M 3/4"
Packing material		PTFE-PE

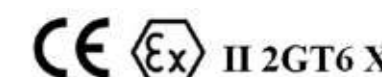

ACCESSORIES KIT	
TRK3181P	REPAIR KIT GASKET PUMP
6836295I	S.STEEL SUCTION HOSE Ø25 F36x2mm 90° M28x1,5 1200mm
6836295AK	FM21906 S. STEEL SUCTION FILTER RACC F28x1,5mm 30M
RAP4860 R7	RETURNED HOSE Ø1/4" MT1.8 F1/4" CONN ONE SIDE



CODE	DESCRIPTION
------	-------------

TKP1871B	APOLLO 303 Transfer 6:1 Bare piston pneumatic transfer pump
----------	---



CODE	DESCRIPTION
------	-------------

TKP5031B	APOLLO 30 Transfer 3:1 Bare piston pneumatic transfer pump
----------	--



### APOLLO 30 Transfer

Piston pneumatic transfer pump suitable for rapid fluid handling in the naval, industrial and refinery sectors with paint, waste fluids, motor oil, gear oil, hydraulic fluid, oil and grease in general. Available with 3:1 and 6:1 ratio.

6:1 RATIO

CODE	DESCRIPTION
TKP2561A	APOLLO 30 Transfer 6:1 Piston pneumatic transfer pump on bracket - Pressure regulator - Complete suction system

		APOLLO 30 6:1
Ratio		6:1
Pump capacity per cycle	cm <sup>3</sup>	334
Stroke	mm	100
Max. Delivery free flow	ltr/min	30
Number of strokes per liter	Bar (PSI)	3
Max. Working outlet pressure	Bar (PSI)	48 (696)
Max. Air inlet pressure	Bar (PSI)	8 (116)
Weight	kg.	15
Air consumption	ltr/min	600 - 2650
Packing type		Mobile
Material inlet fitting size		M 36x2 mm
Material outlet fitting size		M 3/4"
Packing material		PTFE-PE

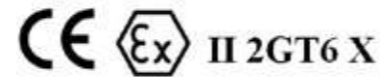

ACCESSORIES KIT	
TRK1630P	REPAIR KIT GASKET PUMP
6836295I	S.STEEL SUCTION HOSE Ø25 F36x2mm 90° M28x1,5mm 1200mm
6836295AK	FM21906 S.STEEL SUCTION FILTER F28x1,5mm 30M CONN.
RAP4860	R7 RETURNED HOSE Ø1/4" MT1.8 F1/4" CONN.ONESIDE



CODE	DESCRIPTION
TKP2561B	APOLLO 30 Transfer 6:1 Bare piston pneumatic transfer pump



### APOLLO 40 Transfer

Piston pneumatic transfer pump suitable for rapid fluid handling in the naval, industrial and refinery sectors with paint, waste fluids, motor oil, gear oil, hydraulic fluid, oil and grease in general. Available with 8:1 and 16:1 ratio.

8:1 RATIO

CODE	DESCRIPTION
TKP5071A	APOLLO 40 Transfer 8:1 Piston pneumatic transfer pump on bracket - Pressure regulator - Complete suction system

		APOLLO 40 8:1
Ratio		8:1
Pump capacity per cycle	cm <sup>3</sup>	500
Stroke	mm	80
Max. Delivery free flow	ltr/min	55
Number of stroke per liter	Bar (PSI)	2
Max. Working outlet pressure	Bar (PSI)	64 (928)
Max. Air inlet pressure	Bar (PSI)	8 (116)
Weight	kg.	28
Air consumption	ltr/min	600 - 2650
Packing type		Mobile
Material inlet fitting size		M 36x2 mm
Material outlet fitting size		M 3/4"
Packing material		PTFE-PE-LEATHER



ACCESSORIES KIT	
TRK3181P	REPAIR KIT GASKET PUMP
6836295I	S.STEEL SUCTION HOSE Ø25 F36x2mm 90° M28x1,5 1200mm
6836295AK	FM21906 S.STEEL SUCTION FILTER F28X1,5mm 30M CONN.
RAP4860R7	RETURNED HOSE Ø1/4" MT1.8 F1/4" CONN.ONESIDE



CODE	DESCRIPTION
TKP5071B	APOLLO 40 Transfer 8:1 Bare piston pneumatic transfer pump





### APOLLO 40 Transfer

Piston pneumatic transfer pump suitable for rapid fluid handling in the naval, industrial and refinery sectors with paint, waste fluids, motor oil, gear oil, hydraulic fluid, oil and grease in general. Available with 8:1 and 16:1 ratio.

16:1 RATIO

CODE	DESCRIPTION
TKP25161A	APOLLO 40 Transfer 16:1 Piston pneumatic transfer pump on bracket - Pressure regulator - Complete suction system

		APOLLO 40 16:1
Ratio		16:1
Pump capacity per cycle	cm <sup>3</sup>	200
Stroke	mm	80
Max. Delivery free flow	ltr/min	30
Number of strokes per liter	Bar (PSI)	5
Max. Working outlet pressure	Bar (PSI)	128 (1856)
Max. Air inlet pressure	Bar (PSI)	8 (116)
Weight	kg.	25
Air consumption	ltr/min	600 - 2650
Packing type		Mobile
Material inlet fitting size		M 36x2 mm
Material outlet fitting size		M 3/4"
Packing material		PTFE-PE-LEATHER

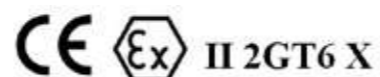

ACCESSORIES KIT	
TRK1630P	REPAIR KIT GASKET PUMP
6836295I	S.STEEL SUCTION HOSE Ø25 F36x2mm90° M28x1,5mm 1200mm
6836295AK	FM21906 S.STEEL SUCTION FILTER F28X1,5mm 30M CONN.
RAP4860R7	RETURNED HOSE Ø1/4" MT1.8 RACC F1/4"ONE SIDE

CODE	DESCRIPTION
TKP25161B	APOLLO 40 Transfer 16:1 Bare piston pneumatic transfer pump





### APOLLO 30 EXT

Pneumatic extrusion piston pump suitable in the automotive, air conditioning and hydraulic, glass, clothing, accessories and electric sectors for transferring glues, silicon, sealants, grease, adhesives, mastic and high viscosity and high-density products.

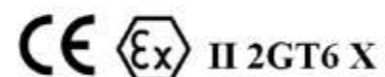

CODE	DESCRIPTION
------	-------------

TKP7030	APOLLO 30 EXT Pneumatic extrusion airless piston pump C/ Double posts pneumatic RAM - 25L Follower plate - Pressure regulators - Lift and dive piston control
---------	---

		APOLLO 30 EXT
Ratio		30:1
Pump capacity per cycle	cm <sup>3</sup>	37
Stroke	mm	100
Max. Delivery free flow	ltr/min	7
Number of strokes per liter		27
Max. Working outlet pressure	Bar (PSI)	240 (3480)
Max. Air inlet pressure	Bar (PSI)	8 (116)
Air consumption	ltr/min	250 - 750
Packing type		Fixed
Material outlet fitting size		M 16x1,5 mm
Packing material		PTFE-PE

All the components in the fluid section are in stainless steel and tungsten carbide, to always guarantee the best quality.

ACCESSORIES KIT	
6381052	HP2 HOSE 3/8" MT.10 M16x1,5mm CONN.
TRK3001P	REPAIR KIT GASKET PUMP



### APOLLO 48 EXT

Pneumatic extrusion piston pump suitable in the automotive, air conditioning and hydraulic, glass, clothing, accessories and electric sectors for transferring glues, silicon, sealants, grease, adhesives, mastic and high viscosity and high-density products.

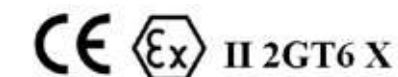

CODE	DESCRIPTION
------	-------------

TKP1848	APOLLO 48 EXT Pneumatic extrusion airless piston pump C/ Double posts pneumatic RAM - 200L Follower plate - Pressure regulators - Lift and dive piston control
---------	--

		APOLLO 48 EXT
Ratio		48:1
Pump capacity per cycle	cm <sup>3</sup>	143
Stroke	mm	100
Max. Delivery free flow	ltr/min	18
Number of stroke per liter-		7
Max. Working outlet pressure	Bar (PSI)	384 (5569)
Max. Air inlet pressure	Bar (PSI)	8 (116)
Air consumption	ltr/min	600 - 2650
Packing type		Fixed
Material outlet fitting size		M 16x1,5 mm
Packing material		PTFE-PE-LEATHER

All the components in the fluid section are in stainless steel and tungsten carbide, to always guarantee the best quality.

ACCESSORIES KIT	
TRK4825P	REPAIR KIT GASKET PUMP
6381052	HP2 HOSE 3/8" MT.10 M16x1,5mm CONN.



### APOLLO 66 EXT

Pneumatic extrusion piston pump suitable in the automotive, air conditioning and hydraulic, glass, clothing, accessories and electric sectors for transferring glues, silicon, sealants, grease, adhesives, mastic and high viscosity and high-density products.



CODE	DESCRIPTION
TKP1866	APOLLO 66 EXT Pneumatic extrusion airless piston pump C/ Double posts pneumatic RAM - 200L Follower plate - Pressure regulators - Lift and dive piston control

		APOLLO 66 EXT
Ratio		66:1
Pump capacity per cycle	cm <sup>3</sup>	100
Stroke	mm	100
Max. Delivery free flow	ltr/min	15
Number of strokes per liter		10
Max. Working outlet pressure	Bar (PSI)	528 (7657)
Max. Air inlet pressure	Bar (PSI)	8 (116)
Air consumption	ltr/min	600 - 2650
Packing type		Fixed
Material outlet fitting size		M 16x1,5 mm
Packing material		PTFE-PE-LEATHER

All the components in the fluid section are in stainless steel and tungsten carbide, to always guarantee the best quality.

ACCESSORIES KIT	
TRK6618P	REPAIR KIT GASKET PUMP
6381052	HP2 HOSE 3/8" MT.10 M16x1,5mm CONN.





# ARES 4200

**Electric diaphragm pump** for professional high-pressure airless paint spraying, suitable for the light construction sector for medium-large surfaces with medium-low viscosity mural products. Available with **vertical or horizontal engine**.

CODE	DESCRIPTION
TKG42C	ARES 4200 Electric airless diaphragm pump volt 230/Hz50 single phase and orizontal C/ Trolley - Manometer - HP hose 7,5m - RST1 spray gun - FM6 tip guard - Reversible FM6 tip - Gravity tank

		ARES 4200
Motor   Volt		230 Volt 50 Hz
Variant		380 Volt 110 Volt
Power		0,74 Kw
Max. Delivery free flow	ltr/min	4
Max. tip	1 Gun	0,021
	2 Guns	0,013
	3 Guns	---
Max. Working outlet pressure	Bar (PSI)	200 (2900)
Max. length hose	mt	60
Max. elevation hose	mt	60
Weight	Kg	26
Material inlet fitting size		M 36x2 mm
Material outlet fitting size		M 16x1,5 mm

### APPLICATION

It can be used with enamels, lacquers, base coats and varnishes, medium and low viscosity water-based paints. The Tsunami/Ares pumps are suitable for low viscosity water-based paints and mural injection resins.

ACCESSORIES KIT	
RST12	HP RST12 SPRAY GUN M16x1,5mm CONN.
614105	HP HOSE 1/4" MT10 M16x1,5mm CONN.
201203	TIP GUARD FOR REVERSIBLE TIPS
FM6XXX	FM6XXX REVERSIBLE TIP
FM61000	WHITE 6L GRAVITY TANK

ACCESSORIES KIT	
TR4103	COMPLETE ARES 4200 DIAPHRAGM
69036212I	S. STEEL SUCTION HOSE Ø19 F36x2 90° M1/2" 750mm
69036212AK	FM60004 SUCTION HOUSING KIT F1/2"
610202I	S. STEEL RETURNED HOSE F20x2mm MT 0,75



CODE	DESCRIPTION
TKG42E	ARES 4200 Electric airless diaphragm pump volt 230/Hz50 single phase and orizontal C/ Trolley - Manometer - HP hose 7,5m - RST1 spray gun - FM6 tip guard - Reversible FM6 tip - Complete suction system



CODE	DESCRIPTION
TKG42B	ARES 4200 Electric airless diaphragm pump volt 230/Hz50 single phase and orizontal C/ Trolley - Manometer - Gravity tank



CODE	DESCRIPTION
TKG42F	ARES 4200 Electric airless diaphragm pump volt 230/Hz50 single phase and orizontal C/ Trolley - Manometer - Complete suction system



CODE	DESCRIPTION
TKG42D	ARES 4200 Electric airless diaphragm pump volt 230/Hz50 single phase and vertical C/ Trolley - Manometer - Gravity tank



CODE	DESCRIPTION
TKG42A	ARES 4200 Electric airless diaphragm pump volt 230/Hz50 single phase and vertical C/ Trolley - Manometer - Complete suction system



# TSUNAMI 65

Electric diaphragm pump for professional high-pressure airless paint spraying, suitable for the light construction sector for medium-large surfaces.

CODE	DESCRIPTION
TKU65E	TSUNAMI 65 Electric airless diaphragm pump volt 230/Hz50 single phase and horizontal C/ Trolley - Manometer - HP hose 7,5m - RST2 spray gun - FM6 tip guard - Reversible FM6 tip - Complete suction system

		TSUNAMI 65
Motor   Volt		230 Volt 50 Hz
Variant		380 Volt 110 Volt
Power		1,49 Kw
Max. Delivery free flow	ltr/min	7,5
Max. tip	1 Gun 2 Guns 3 Guns	0,037 0,017 ---
Max. Working outlet pressure	Bar (PSI)	220 (3190)
Max. length hose	mt	100
Max. elevation hose	mt	100
Weight	Kg	54
Material inlet fitting size		M 36x2 mm
Material outlet fitting size		M 16x1,5 mm

### APPLICATION

Suitable for the light construction sector for medium-large surfaces with medium-low viscosity mural products, enamels, lacquers, base coats and varnishes, medium and low viscosity water-based paints and mural injection resins. The Tsunami/Ares pumps are suitable for low viscosity water-based paints and mural injection resins.

ACCESSORIES KIT	
RST22	HP RST12 SPRAY GUN M16x1,5mm CONN.
614105	HP HOSE 1/4" MT10 M16x1,5mm CONN.
201203	TIP GUARD FOR REVERSIBLE TIPS
FM6XXX	FM6XXX REVERSIBLE TIP
FM61350	WHITE 35 L GRAVITY TANK

ACCESSORIES KIT	
FM61340	ADAPTER M 2" F36x2mm + FILTER + GASKET
TR10103	COMPLETE TSUNAMI 65 DIAPHRAGM
683629I	S. STEEL SUCTION SYSTEM Ø25 F36x2 90° M28x1,5 750mm
683629AK	FM2903 S. STEEL SUCTION FILTER F28x1,5mm M 30
610202I	S. STEEL RETURNED HOSE F 20x2mm M 0.75



CODE	DESCRIPTION
TKU65F	TSUNAMI 65 Electric airless diaphragm pump volt 230/Hz50 single phase and horizontal C/ Trolley - Manometer - HP hose 7,5m - RST2 spray gun - FM6 tip guard - Reversible FM6 tip - 35L gravity tank



CODE	DESCRIPTION
TKU65A	TSUNAMI 65 Electric airless diaphragm pump volt 230/Hz50 single phase and horizontal C/ Trolley - Manometer - Complete suction system



CODE	DESCRIPTION
TKU65D	TSUNAMI 65 Electric airless diaphragm pump volt 230/Hz50 single phase and horizontal C/ Trolley - Manometer - 35L gravity tank



# TSUNAMI 11

Electric diaphragm pump for professional high-pressure airless paint spraying, suitable for the light construction sector for medium-large surfaces.

CODE	DESCRIPTION
TKU11E	TSUNAMI 11 Electric airless diaphragm pump volt 230/Hz50 single phase and orizontal C/ Trolley - Manometer - HP hose 7,5m - RST2 spray gun - FM6 tip guard - Reversible FM6 tip - Complete suction system

		TSUNAMI 11
Motor   Volt		230 Volt 50 Hz
Variant		380 Volt 110 Volt
Power		2,23 Kw
Max. Delivery free flow	ltr/min	9,5
Max. tip	1 Gun 2 Guns 3 Guns	0,043 0,019 ---
Max. Working outlet pressure	Bar (PSI)	220 (3190)
Max. length hose	mt	100
Max. elevation hose	mt	100
Weight	Kg	54
Material inlet fitting size		M 36x2 mm
Material outlet fitting size		M 16x1,5 mm

### APPLICATION

Suitable for the light construction sector for medium-large surfaces with medium-low viscosity mural products, enamels, lacquers, base coats and varnishes, medium and low viscosity water-based paints and mural injection resins.  
The Tsunami/Ares pumps are suitable for low viscosity water-based paints and mural injection resins.

ACCESSORIES KIT	
RST22	HP RST12 SPRAY GUN M16x1,5mm CONN.
614105	HP HOSE 1/4" MT 10 M16x1,5mm CONN.
201203	TIP GUARD FOR REVERSIBLE TIPS
FM6XXX	FM6XXX REVERSIBLE TIP
FM61350	WHITE 35 L GRAVITY TANK

ACCESSORIES KIT	
FM61340	ADAPTER M 2" F36x2mm + FILTER + GASKET
TR10603	COMPLETE TSUNAMI 11 DIAPHRAGM
683629I	S. STEEL SUCTION HOSE Ø25 F36x2 90° M28x1,5 750mm
683629AK	FM2903 S. STEEL SUCTION FILTER F28x1,5mm M 30
610202I	S. STEEL RETURNED HOSE F 20x2mm M 0.75



CODE	DESCRIPTION
TKU11F	TSUNAMI 11 Electric airless diaphragm pump volt 230/Hz50 single phase and orizontal C/ Trolley - Manometer - HP hose 7,5m - RST2 spray gun - FM6 tip guard - Reversible FM6 tip - 35L Gravity tank



CODE	DESCRIPTION
TKU11A	TSUNAMI 11 Electric airless diaphragm pump volt 230/Hz50 single phase and orizontal C/ Trolley - Manometer - Complete suction system



CODE	DESCRIPTION
TKU11D	TSUNAMI 11 Electric airless diaphragm pump volt 230/Hz50 single phase and orizontal C/ Trolley - Manometer - 35L Gravity tank



# MISTRAL

**Peristaltic pump** for low pressure paint spraying suitable in the construction sector for medium-large surfaces. Suitable for the professional painting of interior and exterior plastering, renovations, waterproofing and industrial buildings.

CODE	DESCRIPTION
TI7600	MISTRAL Volumetric rotative peristaltic pump volt 230/Hz50 - C/ Trolley - 35L Gravity tank - Remote control - Bear lance - On/Off remote control - 5 Stainless steel sets nozzles - Twin hose 10m

		MISTRAL
Motor   Volt		230 Volt 60 Hz
Power		0,55 Kw
Max. Delivery free flow	ltr/min	8,5
Max. Working outlet pressure	Bar (PSI)	15 (218)
Weight	Kg	55
Air consumption		300-600

### APPLICATION

Mistral can only be used with a gun equipped with an electronic remote control. It's suitable for all liquid and pasty products, because it is based on a unique volumetric rotating system. It is able to spray paint on all products with a grain size of up to 2.5mm including plasters, decorative laminates, anti-skid and bitumen materials, silicate resins, thermal insulators, insulating pastes, porous cement coatings, putties, artificial resins, fillers, primers, quartz paints, bituminous, fireproof and soundproofing coatings.

ACCESSORIES KIT	
TR78621	STAINLESS STEEL Ø10,5 NOZZLE FOR LANCE
TR78622	STAINLESS STEEL Ø8,5 NOZZLE FOR LANCE
TR78623	STAINLESS STEEL Ø6,5 NOZZLE FOR LANCE

ACCESSORIES KIT	
TR78624	STAINLESS STEEL LANCE Ø4,5
TR78625	STAINLESS STEEL FLAT SHAPE NOZZLE
TT78600	BEAR LANCE



# GEA 4200

**Line marking diaphragm pump** suitable to light duties line marking operations for parking lots and touch up jobs spraying medium and low viscosity road paints. GEA 4200 was designed to trace lines in road works, parking lines, industrial signs, playgrounds and bicycle lanes.

CODE	DESCRIPTION
TKLA	GEA 4200 Line marking airless diaphragm pump - Gas engine C/ Manometer - Hose 10m - RST1 spray gun - FM6 tip gun - Reversible FM6 tip - Complete suction system

		GEA 4200
Motor   Volt		HONDA
Power		3,5 Hp
Max. Delivery free flow	ltr/min	4
Max. tip	1 Gun	0,021
	2 Guns	0,013
	3 Guns	---
Max. Working outlet pressure	Bar (PSI)	200 (2900)
Max. length hose	mt	60
Max. elevation hose	mt	60

### APPLICATION

The GEA pump has an autonomous gas engine which makes it light and easy to handle. Furthermore, thanks to its quick gun coupling system, it is possible to remove the gun from the central trolley and use it individually for further works. Thanks to the directional front wheel with 5 different positions, it is possible to trace straight lines or lines with two different radius measurements.



ACCESSORIES KIT	
RST12	HP RST2 SPRAY GUN M16x1,5mm CONN.
614105	HP HOSE 1/4" MT 10 M16x1,5mm CONN.
201203	TIP GUARD FOR REVERSIBLE TIPS
FM6XXX	FM6XXX REVERSIBLE TIP

ACCESSORIES KIT	
TR4103	COMPLETE GEA 4200 DIAPHRAGM
69036212AK	69036212I.S. STEEL SUCTION HOSE Ø19 F36x2mm M1/2" 750mm
	FM60004 SUCTION HOUSING KIT F1/2"
	610202I S. STEEL RETURNED HOSE F20x2mm MT0.75



### GEA 11000

Line marking diaphragm pump suitable to light duties line marking operations for parking lots and touch up jobs spraying medium and low viscosity road paints. GEA 11000 was designed to trace lines in road works, parking lines, industrial signs, playgrounds and bicycle lanes.

CODE	DESCRIPTION
TKLC	GEA 11000 Line marking airless diaphragm pump with gas engine C/ Manometer - Hose 10m - RST2 spray gun - FM6 tip gun - Reversible FM6 tip - Complete suction system

		GEA 11000
Motor   Volt		HONDA
Power		11,7 Hp
Max. Delivery free flow	ltr/min	9,5
Max. tip	1 Gun	0,043
	2 Guns	0,019
	3 Guns	---
Max. Working outlet pressure	Bar (PSI)	220 (3190)
Max. lenght hose	mt	100
Max. elevation hose	mt	100

### APPLICATION

The GEA pump has an autonomous gas engine which makes it light and easy to handle. Furthermore, thanks to its quick gun coupling system, it is possible to remove the gun from the central trolley and use it individually for further works. Thanks to the directional front wheel with 5 different positions, it is possible to trace straight lines or lines with two different radius measurements.



ACCESSORIES KIT	
RST22	HP RST2 SPRAY GUN M16x1,5mm CONN.
614105	HP HOSE 1/4" MT 10 M16x1,5mm CONN.
201203	TIP GUARD FOR REVERSIBLE TIPS
FM6XXX	FM6XXX REVERSIBLE TIP

ACCESSORIES KIT	
TR10603	COMPLETE GEA 11000 DIAPHRAGM
6836291	S. STEEL SUCTION HOSE Ø25 F36x2 90° M28x1,5mm 750mm
683629AK	FM2903 S. STEEL SUCTION FILTER F28x1,5 30M
610202I	S. STEEL RETURNED HOSE F 20x2mm MT 0.75







# MIURA 21000

**Hydraulic piston pump** for airless high-pressure professional paint spraying suitable for treating paint and anti-corrosion with high viscosity products. Available with gas or electric engine.

CODE	DESCRIPTION
TKH21D	MIURA 21000 Hydraulic airless piston pump Volt 230/Hz50 single phase C/Trolley - Inline filter - Manometer - HP hose 10m - RST2 spray gun - FM6 tip guard - Reversible FM6 tip - Complete suction system

### APPLICATION

They can be used in the naval, civil and industrial construction sectors and heavy carpentry with paints, anti-corrosives, intumescent coatings, protective coatings and encapsulants, putties, fillers, injection resins and ready-mix stucco.

		MIURA 21000	
Motor   Volt		230 Volt 50 Hz	
Variante		380 Volt 50 Volt	
Power		2,23 Kw	
Max. Delivery free flow	ltr/min	6,5	
Stroke	mm	80	
Max. tip	1 Gun	0,035	
	2 Guns	0,017	
	3 Guns	---	
Max. Working outlet pressure	Bar (PSI)	240 (3480)	
Max. length hose	mt	100	
Max. elevation hose	mt	100	
Packing material	Kg	PTFE	
Material outlet fitting size		M 16x1,5 mm	

#### ACCESSORIES KIT

RST22	HP RST2 SPRAY GUN 16x1,5mm CONN.
6381052	HP2 HOSE 3/8" MT.10 M16x1,5mm CONN.
201203	TIP GUARD FOR REVERSIBLE TIPS
FM6XXX	FM6XXX REVERSIBLE TIP

		MIURA 21000G	
Motor		HONDA	
Power		8,4 Hp	
Max. Delivery free flow	ltr/min	6,8	
Stroke	mm		
Max. tip	1 Gun	0,037	
	2 Guns	0,017	
	3 Guns	---	
Max. Working outlet pressure	Bar (PSI)	280 (4061)	
Max. length hose	mt	100	
Max. elevation hose	mt	100	
Packing material		PTFE	
Material outlet fitting size		M 16x1,5 mm	

#### ACCESSORIES KIT

TR21603	UPPER AND LOWER PACKING SET
6803625I	S. STEEL SUCTION HOSE Ø25 F36x2mm M28x1,5mm 1200mm
FM21906	S. STEEL SUCTION FILTER F28x1,5 30M CONN.
6102025I	S. STEEL RETURNED HOSE F 20x2mm 1200mm



CODE	DESCRIPTION
TKH21E	MIURA 21000 Hydraulic airless piston pump volt 230/Hz50 single phase C/Trolley - Inline filter - Manometer - HP hose 10m - RST2 spray gun - FM6 tip guard - Reversible FM6 tip - Direct suction



CODE	DESCRIPTION
TKH21A	MIURA 21000 Hydraulic airless piston pump volt 230/Hz50 single phase C/Trolley - Inline filter - Manometer - Direct suction



CODE	DESCRIPTION
TKH21F	MIURA 21000 Hydraulic airless piston pump with gas engine C/Trolley - Inline filter - Manometer - HP hose 10m - RST2 spray gun - FM6 tip guard - Reversible FM6 tip - Complete suction system



CODE	DESCRIPTION
TKH21G	MIURA 21000 Hydraulic airless piston pump with gas engine C/Trolley - Inline filter - Manometer - HP hose 10m - RST2 spray gun - FM6 tip guard - Reversible FM6 tip - Direct suction



CODE	DESCRIPTION
TKH21C	MIURA 21000 Hydraulic airless piston pump with gas engine C/Trolley - Inline filter - Manometer - Direct suction



# MIURA 44000

**Hydraulic piston pump** for airless high-pressure professional paint spraying suitable for treating paint and anti-corrosion with high viscosity products. Available with **gas** or **electric** engine.

### CODE DESCRIPTION

TKH44D	MIURA 44000 Hydraulic airless piston pump Volt 230/Hz50 single phase C/Trolley - Inline filter - Manometer - HP hose 10m - RST2 spray gun - FM6 tip guard - Reversible FM6 tip - Complete suction system
--------	--

### APPLICATION

It can be used with paints, anti-corrosives, intumescent coatings, protective coatings and encapsulants (water-based and solvent), putties, ready-mix stucco, fillers and mural injection resins.

		MIURA 44000
Motore   Volt		230V
Power		2,23 Kw
Max. Delivery free flow	ltr/min	10,5
Stroke	mm	100
Max. tip	1 Gun	0,037
	2 Guns	0,017
	3 Guns	---
Max. Working outlet pressure	Bar (PSI)	240 (3480)
Max. length hose	mt	150
Max. elevation hose	mt	150
Packing material		PTFE
Material outlet fitting size		M 16x1,5 mm

		MIURA 44000	MIURA 44000G
Motore   Volt		380V	HONDA
Power		4 Kw	11,7 Hp
Max. Delivery free flow	ltr/min	14,2	14,2
Stroke	mm	100	100
Max. tip	1 Gun	0,063	0,063
	2 Guns	0,036	0,036
	3 Guns	0,023	0,023
Max. Working outlet pressure	Bar (PSI)	280 (4061)	280 (4061)
Max. length hose	mt	150	150
Max. elevation hose	mt	150	150
Packing material		PTFE	PTFE
Material outlet fitting size		M 16x1,5 mm	M 16x1,5 mm

#### ACCESSORIES KIT

RST22	HP RST2 SPRAY GUN 16x1,5mm CONN.
6381052	HP2 HOSE 3/8" MT.10 M16x1,5mm CONN.
201203	TIP GUARD FOR REVERSIBLE TIPS
FM6XXX	FM6XXX REVERSIBLE TIP

#### ACCESSORIES KIT

TR44806	UPPER AND LOWER PACKING SET
6803625I	S. STEEL SUCTION HOSE Ø25 F36x2mm M28x1,5 1200mm
683625AK	FM21906 S. STEEL SUCTION FILTER F28x1,5mm 30M CONN.
6102025I	S. STEEL RETURNED HOSE F 20x2mm 1200mm



### CODE DESCRIPTION

TKH44E	MIURA 44000 Hydraulic airless piston pump volt 230/Hz50 single phase C/Trolley - Inline filter - Manometer - HP hose 10m - RST2 spray gun - FM6 tip guard - Reversible FM6 tip - Direct suction
--------	---



### CODE DESCRIPTION

TKH44C	MIURA 44000 Hydraulic airless piston pump volt 230/Hz50 single phase C/Trolley - Inline filter - Manometer - Direct suction
--------	---



### CODE DESCRIPTION

TKH44A	MIURA 44000 Hydraulic airless piston pump volt 380/Hz50 single phase C/Trolley - Inline filter - Manometer - Direct suction
--------	---



### CODE DESCRIPTION

TKH44B	MIURA 44000 Hydraulic airless piston pump with gas engine C/ Trolley - Inline filter - Manometer - Direct suction
--------	---



**miura**  
21000 mix

Two component hydraulic airless piston pump, suitable for painting and anti-corrosion treatment with high viscosity products. Available in two variants: MIX 9 and MIX 18.

MIX 9

CODE	DESCRIPTION
------	-------------

TK21400	MIURA 21000 MIX 9 Two component hydraulic airless piston pump Volt 230/50 HZ single phase C/ Trolley - 2 Inline filters - 2 Manometers - 2 Complete suction systems
---------	---

	MIURA 21000 MIX 9
Motor   Volt	230V 50 Hz
Power	2,23 Kw
Mixing ratio	1:1
Stroke	mm 80
Max. Delivery free flow	Bar (PSI) 9
Max. Working outlet pressure	ltr/min 220 (3190)
Material outlet fitting size	M 16x1,5 mm

### APPLICATION

It can be used with bicomponent products, paints, anti-corrosives, intumescent coatings, protective coatings and encapsulants (water-based and solvent), putties, ready-mix stucco, fillers and mural injection resins.

ACCESSORIES KIT	
RST21	HP RST2 SPRAY GUN 1/4" CONN.
614104	HP HOSE 1/4" MT10 1/4" CONN.
201203	TIP GUARD FOR REVERSIBLE TIPS
FM6XXX	FM6XXX REVERSIBLE TIP
FM61000	WHITE 6L GRAVITY TANK

ACCESSORIES KIT	
FM610062	"U" OBLIQUE ADAPTER M36x2mm X F36x2mm
TRK4010P	REPAIR KIT GASKET PUMP
69034912AK	69034912I S.S. STEEL SUCTION SYSTEM Ø19 F36x2mm 90° M1/2" 750mm
69034912AK	FM60004 SUCTION HOUSING KIT F1/2"
69034912AK	RAP3040 R7 RETURNED HOSE Ø1/4" MT1.5 F1/4" CONN. ONE SIDE



CODE	DESCRIPTION
------	-------------

TK21401	MIURA 21000 MIX 9 Two component hydraulic airless piston pum with gas engine C/ Trolley - 2 Inline filters - 2 Manometers - 2 Complete suction systems
---------	--



**miura**  
21000 mix

Two component hydraulic airless piston pump, suitable for painting and anti-corrosion treatment with high viscosity products. Available in two variants: MIX 9 and MIX 18.

MIX 18

CODE	DESCRIPTION
------	-------------

TK21450	MIURA 21000 MIX 18 Two component hydraulic airless piston pump Volt 230/50 HZ single phase C/ Trolley - 2 Inline filters - 2 Manometers - 2 Complete suction systems
---------	--

	MIURA 21000 MIX 18
Motor   Volt	230V 50 Hz
Power	2,23 Kw
Mixing ratio	1:1
Stroke	mm 80
Max. Delivery free flow	Bar (PSI) 18
Max. Working outlet pressure	ltr/min 120 (1740)
Material outlet fitting size	M 16x1,5 mm

### APPLICATION

It can be used with bicomponent products, paints, anti-corrosives, intumescent coatings, protective coatings and encapsulants (water-based and solvent), putties, ready-mix stucco, fillers and mural injection resins.

ACCESSORIES KIT	
RST21	HP RST2 SPRAY GUN 1/4" CONN.
614104	HP HOSE 1/4" MT 10 1/4" CONN.
201203	TIP GUARD FOR REVERSIBLE TIPS
FM6XXX	FM6XXX REVERSIBLE TIP
FM61000	WHITE 6L GRAVITY TANK

ACCESSORIES KIT	
FM610062	"U" OBLIQUE ADAPTER M36x2 X F36x2mm
TRK4010P	REPAIR KIT GASKET PUMP
69034912AK	69034912I S.S. STEEL SUCTION SYSTEM Ø19 F36x2mm 90° M1/2" 750mm
69034912AK	FM60004 SUCTION HOUSING KIT F1/2"
69034912AK	RAP3040 R7 RETURNED HOSE Ø1/4" MT1.5 F1/4" CONN. ONE SIDE



CODE	DESCRIPTION
------	-------------

TK21451	MIURA 21000 MIX 18 Two component hydraulic airless piston pum with gas engine C/ Trolley - 2 Inline filters - 2 Manometers - 2 Complete suction systems
---------	---



# B24

**Pneumatic double diaphragm pump** suitable for low-pressure air spraying with paint atomization air or low-medium viscosity fluid transfer. Available in the plastic variant **BOXER**.

CODE	DESCRIPTION
212404	B24 Pneumatic double diaphragm pump C/ Trolley - Pressure regulator - Inline filter - Fluid regulator - LP hose 7,5m - Spray gun - Complete suction system

		B24
Motor		Pneumatic
Mixing ratio		1:1
Max. Delivery free flow	ltr/min	24
Max. Working inlet pressure	Bar (PSI)	8 (116)
Max. Working outlet pressure	Bar (PSI)	8 (116)
Weight	kg.	11
Air consumption	ltr/min	200 - 500
Material inlet fitting size		M 1/2"
Material outlet fitting size		M 3/8"

### APPLICATION

It can be used with enamels, lacquers, base coats and varnishes, in the wood and metal sector.

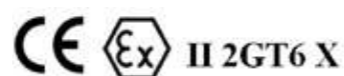

ACCESSORIES KIT	
10710XX	S 710 SPRAY GUN SSP
6668750	LP TWIN HOSE 6x8 mt. 7,5 RACC 1/4"
040119K	NYLON KIT DIAPHRAGM B24 / BOXER
040224K	RUBBER KIT DIAPHRAGM + PTFE B24 / BOXER

ACCESSORIES KIT	
520003	6L GRAVITY TANK "L" ADAPTER
690012 S.	STEEL SUCTION SYSTEM Ø13 F1/2" M15x1" 750mm
690012K	FM60005 SUCTION HOUSING KIT F15x1"
	35068 RILSAN HOSE 6x8 1MT



CODE	DESCRIPTION
212405	B24 Pneumatic double diaphragm pump C/ Trolley - Pressure regulator - Inline filter - Fluid regulator - LP hose 7,5m - Spray gun - Gravity tank with adapter



CODE	DESCRIPTION
212403	B24 Pneumatic double diaphragm pump C/ Trolley - Pressure regulator - Inline filter - Fluid regulator



CODE	DESCRIPTION
212402	B24 Pneumatic double diaphragm pump C/ Trolley - Pressure regulator - Inline filter



CODE	DESCRIPTION
212400	B24 Pneumatic double diaphragm transfer pump C/ Pressure regulator
212401	B24 Bare pneumatic double diaphragm transfer pump



CODE	DESCRIPTION
TK13000	BOXER Pneumatic double diaphragm transfer pump C/ Pressure regulator
TK13001	BOXER Bare pneumatic double diaphragm transfer pump

# PUMPS

## B24 MIX | Pneumatic Double Diaphragm pump



# B24

Mix

**Two-component double diaphragm pneumatic pump** suitable for low-pressure air spraying with paint atomization air. It can be used with bicomponent products, enamels, lacquers, low and medium viscosity base coats and varnishes, in the wood and metal sector.

CODE	DESCRIPTION
TK212401	B24 MIX Two-component pneumatic double diaphragm pump C/ Trolley - Pressure regulator control plate - 2 Inline filters - Static mixer - LP hose 7,5m - Spray gun - 2 Complete suction systems  BOXER Pneumatic double diaphragm flushing pump C/ Pressure regulator - Complete suction system

		B24 MIX
Motor		Pneumatic
Mixing ratio		1:1
Max. Delivery free flow	ltr/min	12
Max. Working inlet pressure	Bar (PSI)	8 (116)
Max. Working outlet pressure	Bar (PSI)	8 (116)
Weight	kg.	45
Air consumption	ltr/min	250 - 400
Material inlet fitting size		M 1/2"
Material outlet fitting size		M 3/8"

ACCESSORIES KIT	
10710XX	S710 SPRAY GUN SSP
6668750	LP TWIN HOSE 6x8 mt. 7,5 1/4" CONN.
040119K	NYLON DIAPHRAGM KIT B24 / BOXER
040224K	RUBBER DIAPHRAGM KIT + PTFE B24/BOXER

ACCESSORIES KIT	
520003	6L GRAVITY TANK "L" ADAPTER
690012	S.STEEL SUCTION SYSTEM Ø13 F1/2" M15x1" 750mm
690012K	FM60005 SUCTION HOUSING KIT F15x1"
35068	RILSAN HOSE 6x8 1M



CODE	DESCRIPTION
TK212400	B24 MIX Two-component pneumatic double diaphragm pump C/ Trolley - Pressure regulator control plate - 2 Inline filters - Static mixer - 2 Complete suction systems  BOXER Pneumatic double diaphragm flushing pump C/ Pressure regulator - Complete suction system



## MANUAL HIGH PRESSURE SPRAY GUNS



Berizzi produces and supplies manual paint spray guns (airless and air-assisted airless) able to provide high quality finishing and transfer efficiency, while ensuring maximum user comfort. These spray guns are compatible with the main brand available on the sector (Graco, Wagner, Optima, Kremlin, Anest Iwata, Binks, Wiwa and Titan).

Berizzi spray guns allow to satisfy every painting need determined by the type of material, the flow rate and the degree of finishing required. They can be used for airless or air assisted airless spraying, for different applications and materials.

Each gun has a dedicated repair kit that allows to keep the gun in the best working conditions providing the best finishing performances.

AIR-ASSISTED AIRLESS  
AIRLESS

page 58  
page 61

# MANUAL HIGH PRESSURE SPRAY GUNS

## AIR-ASSISTED AIRLESS

## MACH3 | COMPATIBLE WITH THE FOLLOWING BRANDS



Manual air-assisted airless high pressure spray gun. Designed to improve the application and quality, can be installed to our pumps, and it is suitable for spraying applications in the metal and wood finishing industry and it is compatible with the air caps and nozzles of the main brands available in this sector.

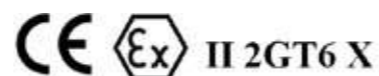

### ADVANTAGES

- High quality finishing
- Even coverage
- Uniform jet spraying
- Quick application
- Better atomizing quality

### TECHNICAL SPECIFICATIONS

MAX. WORKING FLUID PRESSURE	200 Bar /2900 psi
MAX. WORKING AIR PRESSURE	7 bar/100 psi
MAX. WORKING FLUID TEMPERATURE	43° C
FLUID INLET	1/4" nps
AIR INLET	1/4" nps
GUN WEIGHT	520gr
GUN BODY	Forged aluminum
TRIGGER RESISTANCE	17.35 N
WETTED PARTS	Stainless steel, carbide, PTFE

### CODE DESCRIPTION

TT1001	Mach3 with s/s short filter holder + filter + TT1 nozzle + TT1 aircap
FM63000	Stainless steel filter holder inlet 1/4" NPS
TT1MIX	Air cap for TT1 nozzle
TTUXXX	Nozzle mix type TT1



CODE	DESCRIPTION
TT1001K	Mach3 with s/s short filter holder + filter + KN nozzle + KN aircap
TT1MIXK	Aircap for nozzle type mix Kremlin
KKN4XX	Nozzle type mix Kremlin

### KREMLIN



CODE	DESCRIPTION
TT1001G	Mach3 gun + filter holder + nozzle GWN + aircap GWN
TT1MIXG	Aircap for nozzle type mix Graco
GWNXXX	Nozzle type mix Graco

### GRACO



CODE	DESCRIPTION
TT1001W	Mach3 gun + filter holder + nozzle WGM + aircap WGM
TT1MIXW	Aircap for nozzle type mix Wagner
WGMXXX	Nozzle type mix Wagner

### WAGNER



CODE	DESCRIPTION
TT1001ON	Mach3 gun + filter holder + nozzle ON + aircap ON
TT1MIXON	Aircap for nozzle type mix Optima 2000
ONXXXX	Nozzle type mix Optima 2000

### OPTIMA 20



CODE	DESCRIPTION
TT1001OPN	Mach3 gun + filter holder + nozzle OPN + aircap OPN
TT1MIXOPN	Aircap for nozzle type mix Optima 2100
OPNXXX	Nozzle type mix Optima 2100

### OPTIMA 21

# MANUAL HIGH PRESSURE SPRAY GUNS

MACH3 WITH REVERSIBLE TIP

AIRLESS - 250 Bar



**M3**  
MACH

CE II 2GT6 X

CODE	DESCRIPTION
TT1201	Mach3 gun + filter holder + tip + tip guard
FM63000	Stainless steel filter holder inlet 1/4" NPS
201305	Tip guard
FMC6XXX	Reversible tip FMC6 fine finish
201204	Repair kit tip guard

## REVERSIBLE TIP FMC6



## TIP GUARD



**B2000**

Manual airless high pressure gun, 250 Bar

TECHNICAL SPECIFICATIONS	
MAX. PRESSURE	250 Bar / 3625 psi
GUN WEIGHT	480gr
Ø BALL	Ø5

CE II 2GT6 X

CODE	DESCRIPTION
104001	Gun B2000 bar 250 connection 1/4" NPS
104001B	Gun B2000 bar 250 connection 1/4" BSP
104001G	Gun B2000 bar 250 connection 1/4" NPS Diff 7/8"
104001GB	Gun B2000 bar 250 connection 1/4" BSP Diff 7/8"
104002	Gun B2000 bar 250 connection 16x1,5mm
104002G	Gun B2000 bar 250 connection 16x1,5mm Diff 7/8"
104003	Gun B2000 bar 250 connection 1/2" JIC
104004	Gun B2000 bar 250 connection 3/8"
505250	Repair kit for B2000 11/16"
505250G	Repair kit for B2000 7/8"



# MANUAL HIGH PRESSURE SPRAY GUNS

AIRLESS - 300 Bar



TWO-FINGER TRIGGER

## RST<sub>1</sub>

CODE	DESCRIPTION
RST11C	Airless gun RST1 Ø5 connection 1/4" NPS Diff 11/16"
RST11CB	Airless gun RST1 Ø5 connection 1/4" BSP Diff 11/16"
RST12C	Airless gun RST1 Ø5 connection 16x1,5mm Diff 11/16"
RST13C	Airless gun RST1 Ø5 connection 1/4" NPS Diff 7/8"
RST13CB	Airless gun RST1 Ø5 connection 1/4" BSP Diff 7/8"
RST14C	Airless gun RST1 Ø5 connection 16x1,5mm Diff 7/8"
RST1K	Repair kit RST1 Ø5 Diff 11/16"
RST1KG	Repair kit RST1 Ø5 Diff 7/8"

Manual airless high pressure spray gun with stainless steel swivel to guarantee the best comfort and hand freedom during the work. Suitable for spraying of medium viscosity materials with electric and pneumatic airless pumps. 300 Bar. It's available with two-finger or four-finger trigger.

TECHNICAL SPECIFICATIONS	
MAX. PRESSURE	300 Bar /4350 psi
GUN WEIGHT	430gr
Ø BALL	Ø5

300 Bar

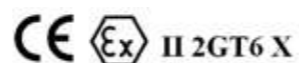

CODE	DESCRIPTION
RST11	Airless gun RST1 Ø5 connection 1/4" NPS Diff 11/16"
RST11B	Airless gun RST1 Ø5 connection 1/4" BSP Diff 11/16"
RST12	Airless gun RST1 Ø5 connection 16x1,5mm Diff 11/16"
RST13	Airless gun RST1 Ø5 connection 1/4" NPS Diff 7/8"
RST13B	Airless gun RST1 Ø5 connection 1/4" BSP Diff 7/8"
RST14	Airless gun RST1 Ø5 connection 16x1,5mm Diff 7/8"
RST1K	Repair kit RST1 Ø5 Diff 11/16"
RST1KG	Repair kit RST1 Ø5 Diff 7/8"

FOUR-FINGER TRIGGER

AIRLESS - 500 Bar



FOUR-FINGER TRIGGER

## RST<sub>2</sub>

Manual airless high pressure spray gun with stainless steel swivel to guarantee the best comfort and hand freedom during the work. 500 Bar. It's available with two-finger or four-finger trigger.

TECHNICAL SPECIFICATIONS	
MAX. PRESSURE	500 Bar /7250 psi
GUN WEIGHT	520gr
Ø BALL	Ø3 - Ø5
TRIGGER RESISTANCE	12N / 1Kg

500 Bar



Ø3

CODE	DESCRIPTION
RST21	Airless gun RST2 Ø3 connection 1/4" NPS Diff 11/16"
RST21B	Airless gun RST2 Ø3 connection 1/4" BSP Diff 11/16"
RST22	Airless gun RST2 Ø3 connection 16x1,5mm Diff 11/16"
RST23	Airless gun RST2 Ø3 connection 1/4" NPS Diff 7/8"
RST23B	Airless gun RST2 Ø3 connection 1/4" BSP Diff 7/8"
RST24	Airless gun RST2 Ø3 connection 16x1,5mm Diff 7/8"
RST2K	Repair kit RST2 Ø3 Diff 11/16"
RST2KG	Repair kit RST2 Ø3 Diff 7/8"

Ø5

CODE	DESCRIPTION
RST25	Airless gun RST2 Ø5 connection 1/4" NPS Diff 11/16"
RST25B	Airless gun RST2 Ø5 connection 1/4" BSP Diff 11/16"
RST26	Airless gun RST2 Ø5 connection 16x1,5mm Diff 11/16"
RST27	Airless gun RST2 Ø5 connection 1/4" NPS Diff 7/8"
RST27B	Airless gun RST2 Ø5 connection 1/4" BSP Diff 7/8"
RST28	Airless gun RST2 Ø5 connection 16x1,5mm Diff 7/8"
RST2K5	Repair kit RST2 Ø5 Diff 11/16"
RST2KG5	Repair kit RST2 Ø5 Diff 7/8"

# MANUAL HIGH PRESSURE SPRAY GUNS

AIRLESS - 500 Bar



## RST2

Manual airless high pressure spray gun with stainless steel swivel to guarantee the best comfort and hand freedom during the work. 500 Bar. It's available with two-finger or four-finger trigger.

### TECHNICAL SPECIFICATIONS

MAX. PRESSURE	500 Bar /7250 psi
GUN WEIGHT	520gr
Ø BALL	Ø3 - Ø5
TRIGGER RESISTANCE	12N / 1Kg

500 Bar   II 2GT6 X

Ø3

TWO-FINGER TRIGGER

### CODE DESCRIPTION

RST21C	Airless gun RST2 Ø3 connection 1/4" NPS Diff 11/16"
RST21CB	Airless gun RST2 Ø3 connection 1/4" BSP Diff 11/16"
RST22C	Airless gun RST2 Ø3 connection 16x1,5mm Diff 11/16"
RST23C	Airless gun RST2 Ø3 connection 1/4" NPS Diff 7/8"
RST23CB	Airless gun RST2 Ø3 connection 1/4" BSP Diff 7/8"
RST24C	Airless gun RST2 Ø3 connection 16x1,5mm Diff 7/8"
RST2K	Repair kit RST2 Ø3 Diff 11/16"
RST2KG	Repair kit RST2 Ø3 Diff 7/8"

Ø5

### CODE DESCRIPTION

RST25C	Airless gun RST2 Ø5 connection 1/4" NPS Diff 11/16"
RST25CB	Airless gun RST2 Ø5 connection 1/4" BSP Diff 11/16"
RST26C	Airless gun RST2 Ø5 connection 16x1,5mm Diff 11/16"
RST27C	Airless gun RST2 Ø5 connection 1/4" NPS Diff 7/8"
RST27CB	Airless gun RST2 Ø5 connection 1/4" BSP Diff 7/8"
RST28C	Airless gun RST2 Ø5 connection 16x1,5mm Diff 7/8"
RST2K5	Repair kit RST2 Ø5 Diff 11/16"
RST2KG5	Repair kit RST2 Ø5 Diff 7/8"

AIRLESS - 500 Bar

## B500

Manual airless high pressure spray gun, 500 Bar. Thanks to the external material passage, material isn't in contact with the needle.



### TECHNICAL SPECIFICATIONS

MAX. PRESSURE	500 Bar /7250 psi
GUN WEIGHT	600gr
Ø BALL	Ø5

### CODE DESCRIPTION

104005	Gun B500 connection 1/4" NPS Diff 11/16"
104005B	Gun B500 connection 1/4" BSP Diff 11/16"
104006	Gun B500 connection 16x1,5mm Diff 11/16"
104007	Gun B500 connection 1/2" JIC Diff 11/16"
104010	Gun B500 connection 3/8" Diff 11/16"
104005G	Gun B500 connection 1/4" NPS Diff 7/8"
104005GB	Gun B500 connection 1/4" BSP Diff 7/8"
104006G	Gun B500 connection 16x1,5mm Diff 7/8"
502000	Repair kit B500 Diff 11/16"
502000G	Repair kit B500 Diff 7/8"



  II 2GT6 X

## B90

Manual airless high pressure spray gun. 500 Bar. The parts of B90 are compatible with the gun K90 AOM.



### TECHNICAL SPECIFICATIONS

MAX. PRESSURE	500 Bar /7250 psi
GUN WEIGHT	570gr
Ø BALL	Ø5

### CODE DESCRIPTION

109004	Gun B90 conn. 1/4" NPS Diff 11/16"
109004B	Gun B90 conn. 1/4" BSP Diff 11/16"
109005	Gun B90 conn. 16x1,5mm Diff 11/16"
109004G	Gun B90 conn. 1/4" NPS Diff 7/8"
109004GB	Gun B90 conn. 1/4" BSP Diff 7/8"
109005G	Gun B90 conn. 16x1,5mm Diff 7/8"
505000G	Repair kit B90 Diff 7/8"
505000K	Repair kit B90 type Asturo
505000	Repair kit B90 Diff 11/16"



  II 2GT6 X

# MANUAL HIGH PRESSURE SPRAY GUNS

AIRLESS - 500 Bar

AIRLESS

## RST7

Manual airless high pressure gun ideal for spraying high viscosity materials using large diameter hoses even in extreme conditions. 500 bar. The robust and ergonomic construction and the swivel connection make the RST7 handling practical and light in any condition. The spray gun is made of sturdy, high-quality materials for long-term use.

### TECHNICAL SPECIFICATIONS

MAX. PRESSURE	500 Bar /7250 psi
GUN WEIGHT	480gr
Ø BALL	Ø5

500 Bar   II 2GT6 X



### CODE DESCRIPTION



RST71	Airless gun RST7 connection 1/4" NPS Diff. 11/16"
RST71B	Airless gun RST7 connection 1/4" BSP Diff. 11/16"
RST72	Airless gun RST7 connection 1/4" NPS Diff. 7/8"
RST72B	Airless gun RST7 connection 1/4" BSP Diff. 7/8"
RST73	Airless gun RST7 connection 3/8" Diff. 11/16"
RST74	Airless gun RST7 connection 3/8" Diff. 7/8"
RST75	Airless gun RST7 connection 1/2" Diff. 11/16"
RST76	Airless gun RST7 connection 1/2" Diff. 7/8"
RST7K	Repair kit RST7 Diff. 11/16"
RST7KG	Repair kit RST7 Diff. 7/8"
20150	Nozzles for silicones Ø1,5mm
20200	Nozzles for silicones Ø2mm

## TK LINE

Manual airless high pressure spray gun, suitable for glues and sealants. 250 Bar

### TECHNICAL SPECIFICATIONS

MAX. PRESSURE	250 Bar /3625 psi
GUN WEIGHT	410gr
Ø BALL	Ø5

  II 2GT6 X

### CODE DESCRIPTION

TT75000	TK Line conn. M 16x1,5mm Diff. 11/16"
TT75005	TK Line conn. M 1/4" NPS Diff. 11/16"
TT75005B	TK Line conn. M 1/4" BSP Diff. 11/16"
TT75005G	TK Line conn. M 1/4" NPS Diff. 7/8"
TT75005GB	TK Line conn. M 1/4" BSP Diff. 7/8"
TT75000G	TK Line conn. M 16x1,5mm Diff. 7/8"
20150	Nozzles for silicones Ø1,5mm
20200	Nozzles for silicones Ø2mm



## TK MIX

Manual airless high pressure spray gun. Thanks to the double passage of materials, this gun is suitable for applying bi-components products with external mixing.

### TECHNICAL SPECIFICATIONS

MAX. PRESSURE	500 Bar /7250 psi
GUN WEIGHT	980gr
Ø BALL	Ø5

### CODE DESCRIPTION

TT77495	Gun TK Mix conn. 1/4" NPS Diff. 11/16"
TT77495	Gun TK Mix conn. 1/4" BSP Diff. 11/16"
TT77490	Gun TK Mix conn. 16x1,5mm Diff. 11/16"

## AUTOMATIC HIGH PRESSURE SPRAY GUNS



Berizzi produces and supplies automatic paint spraying spray guns to be installed in automatic spraying systems, booths and painting systems. Airless or air-assisted airless spray guns are both available, usable for different applications and materials and able to guarantee maximum transfer efficiency, high finishing quality and production speed on large surfaces where high coating thickness is required.

Each gun has a dedicated repair kit that allows to keep the gun in the best working conditions providing the best finishing performances.

AIR-ASSISTED AIRLESS  
AIRLESS

page 70  
page 73

# AUTOMATIC HIGH PRESSURE SPRAY GUNS

AIR-ASSISTED AIRLESS

MACH5 | COMPATIBLE WITH THE FOLLOWING BRAND



**Automatic air-assisted airless high pressure spray gun.** Designed to improve the application and quality, can be installed to our pumps, and it is suitable for spraying applications in the metal and wood finishing industry and it is compatible with the air caps and nozzles of the main brands available in this sector.

Each gun has a dedicated **repair kit** that allows to keep the gun in the best working conditions providing the best finishing performances.



CODE	DESCRIPTION
TT1301	Mach5 spray gun + nozzle + air cap
TT1MIX	Air cap for nozzle Mix type TT1
TTUXXX	Nozzle Mix type TT1
TTK4058	Repair kit



## ADVANTAGES

- High quality finishing
- Even coverage
- Uniform jet spraying
- Quick application
- Better atomizing quality

## TECHNICAL SPECIFICATIONS

Maximum working fluid pressure	200 bar, 20 MPa (2900 psi)
Maximum working air pressure	7 bar, 0,7 MPa (100 psi)
Maximum working fluid temperature	63° C
Fluid inlet	1/4" nps
Needle opening air inlet	Ø6
Air cap regulation air inlet	Ø6
Gun weight	980 gr
Gun body	Stainless steel
Wetted parts	Stainless steel, carbide, PTFE



KREMLIN

CODE	DESCRIPTION
TT1301K	Mach5 spray gun + nozzle KN + air cap KN
TT1MIXK	Air cap for nozzle Mix type Kremlin
KKK4XX	Nozzle Mix type Kremlin
TTK4058	Repair kit



GRACO

CODE	DESCRIPTION
TT1301G	Mach5 spray gun + nozzle GWN + air cap GWN
TT1MIXG	Air cap for nozzle Mix type Graco
GWNXXX	Nozzle Mix type Graco
TTK4058	Repair kit



WAGNER

CODE	DESCRIPTION
TT1301W	Mach5 spray gun + nozzle WGM + air cap WGM
TT1MIXW	Air cap for nozzle Mix type Wagner
WGMXXXX	Nozzle type Wagner
TTK4058W	Repair kit

# AUTOMATIC HIGH PRESSURE SPRAY GUNS

MACH5 | COMPATIBLE WITH THE FOLLOWING BRAND

AIRLESS



OPTIMA 20

CODE	DESCRIPTION
TT1301ON	Mach5 spray gun + nozzle ON + air cap ON
TT1MIXON	Air cap for nozzle Mix type Optima 2000
ONXXXX	Nozzle Mix type Optima 2000
TTK4058O	Repair kit ON-OPN



OPTIMA 21

CODE	DESCRIPTION
TT1301OPN	Mach5 spray gun + nozzle OPN + air cap OPN
TT1MIXOPN	Air cap for nozzle Mix type Optima 2100
OPNXXX	Nozzle Mix type Optima 2100
TTK4058O	Repair kit ON-OPN

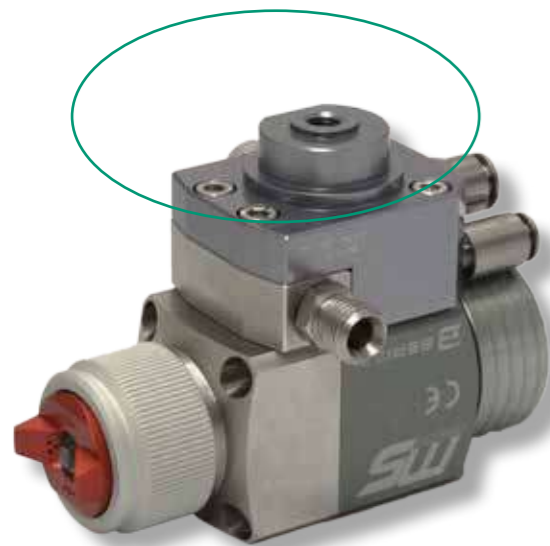

With **CEFLA** support

For all MACH5 spray guns

CODE	DESCRIPTION
TT1301C	Mach5 with Cefla support + nozzle + air cap
TT1301KC	Mach5 with Cefla support + nozzle KN + air cap KN
TT1301GC	Mach5 with Cefla support + nozzle GWN + air cap GWN
TT1301ONC	Mach5 with Cefla support + nozzle ON + air cap ON
TT1301OPNC	Mach5 with Cefla support + nozzle OPN + air cap OPN
TT1301WC	Mach5 with Cefla support + nozzle WGM + air cap WGM

## RST5

**Automatic high pressure airless spray gun.** Super compact, 233gr - 590gr and with minimum dimensions, it is one of the smallest automatic spray guns on the market. Available in the aluminium or stainless steel version, Thanks to its design it can be used on any robot, in systems with confined spaces and to perform colour change valves in series. The complete needle kit makes it very quick to replace the needle without having to adjust any stroke and above all without having to disassemble the gun from its support. The self-adjusting packing gland guarantees extraordinary durability and resistance over time.

### TECHNICAL SPECIFICATIONS

PRES. MAX	300 Bar/ 4350 psi
GUN WEIGHT	233gr aluminium 590gr s. steel
MATERIAL INLET	1/4" BSP
AIR INLET	Ø4 rapid fitting
Ø BALL	Ø3

### CODE DESCRIPTION

RST51	Automatic spray gun RST5 in aluminium Diff. 11/16"
RST52	Automatic spray gun RST5 in aluminium Diff. 7/8"
RST53	Automatic spray gun RST5 in aluminium 1/2" - swivel
RST54	Automatic spray gun RST5 in aluminium 1/4"
RST2K	Repair kit RST5 Diff. 11/16"
RST2KG	Repair kit RST5 Diff. 7/8"
RST2K2	Repair kit RST5 Diff. 1/2"
RST2K4	Repair kit RST5 Diff. 1/4"



CE  $\text{Ex}$  II 2GT6 X



### CODE DESCRIPTION

RST51I	Automatic spray gun RST5 in stainless steel Diff. 11/16"
RST52I	Automatic spray gun RST5 in stainless steel Diff. 7/8"
RST53I	Automatic spray gun RST5 in stainless steel 1/2"- swivel
RST54I	Automatic spray gun RST5 in stainless steel 1/4"
RST2K	Repair kit RST5 Diff. 11/16"
RST2KG	Repair kit RST5 Diff. 7/8"
RST2K2	Repair kit RST5 Diff. 1/2"
RST2K4	Repair kit RST5 Diff. 1/4"

CE  $\text{Ex}$  II 2GT6 X

# AUTOMATIC HIGH PRESSURE SPRAY GUNS

AIRLESS

NEW

## RST5

Automatic high pressure airless spray gun. Super compact, with minimal dimensions, it is one of the smallest pistols on the market. Available in aluminum or stainless steel version.

The base on which the gun is assembled makes it versatile and suitable for different applications and assemblings. The complete needle kit makes it very quick to replace the needle without having to adjust any stroke and above all without having to disassemble the gun from its support. The self-adjusting packing gland guarantees extraordinary durability and resistance over time.

### TECHNICAL SPECIFICATIONS

PRES. MAX	300 Bar/ 4350 psi
GUN WEIGHT	442gr aluminium 876gr s. steel
MATERIAL INLET	1/4" BSP
AIR INLET	Ø4 rapid fitting
Ø BALL	Ø3



NEW  
BASE

### CODE DESCRIPTION

RST51B	Automatic spray gun RST5 in aluminium Diff. 11/16"
RST52B	Automatic spray gun RST5 in aluminium Diff. 7/8"
RST53B	Automatic spray gun RST5 in aluminium 1/2" - swivel
RST54B	Automatic spray gun RST5 in aluminium 1/4"
RST2K	Repair kit RST5 Diff. 11/16"
RST2KG	Repair kit RST5 Diff. 7/8"
RST2K2	Repair kit RST5 Diff. 1/2"
RST2K4	Repair kit RST5 Diff. 1/4"

CE Ex II 2GT6 X



NEW  
BASE

### CODE DESCRIPTION

RST51BI	Automatic spray gun RST5 in stainless steel Diff. 11/16"
RST52BI	Automatic spray gun RST5 in stainless steel Diff. 7/8"
RST53BI	Automatic spray gun RST5 in stainless steel 1/2"- swivel
RST54BI	Automatic spray gun RST5 in stainless steel 1/4"
RST2K	Repair kit RST5 Diff. 11/16"
RST2KG	Repair kit RST5 Diff. 7/8"
RST2K2	Repair kit RST5 Diff. 1/2"
RST2K4	Repair kit RST5 Diff. 1/4"

CE Ex II 2GT6 X

Automatic airless high pressure spray gun, with body in stainless steel, 500 Bar. Suitable with automatic spraying systems and machines.

### TECHNICAL SPECIFICATIONS

PRES. MAX	500 bar/7250 psi
MATERIAL INLET	1/4" BSP
AIR INLET	Ø6 rapid fitting
GUN WEIGHT	850gr
Ø BALL	Ø5

CE Ex II 2GT6 X

### CODE DESCRIPTION

108100I	Automatic spray gun B81 in stainless steel Diff. 11/16"
108108I	Automatic spray gun B81 in stainless steel Diff. 7/8"
108104I	Automatic spray gun B81 in stainless steel Diff. 1/4"
108102I	Automatic spray gun B81 in stainless steel Diff. 1/2" - swivel
502000	Repair kit for B81 11/16"
502000G	Repair kit for B81 7/8"
502004	Repair kit for B81 1/4"
502002	Repair kit for B81 1/2"

## B81 I



## B81 A



Automatic airless high pressure spray gun with body in aluminium, 500 Bar. Suitable with automatic spraying systems and machines.

### TECHNICAL SPECIFICATIONS

PRES. MAX	500 bar/7250 psi
MATERIAL INLET	1/4" BSP
AIR INLET	Ø6 rapid fitting
GUN WEIGHT	360gr
Ø BALL	Ø5

CE Ex II 2GT6 X

### CODE DESCRIPTION

108100	Automatic spray gun B81 in aluminium Diff. 11/16"
108108	Automatic spray gun B81 in aluminium Diff. 7/8"
108104	Automatic spray gun B81 in aluminium Diff. 1/4"
108102	Automatic spray gun B81 in aluminium Diff. 1/2" - swivel
502000	Repair kit for B81 11/16"
502000G	Repair kit for B81 7/8"
502004	Repair kit for B81 1/4"
502002	Repair kit for B81 1/2"

## PAINT SPRAYING SYSTEMS FOR INTERNAL PIPES COATING

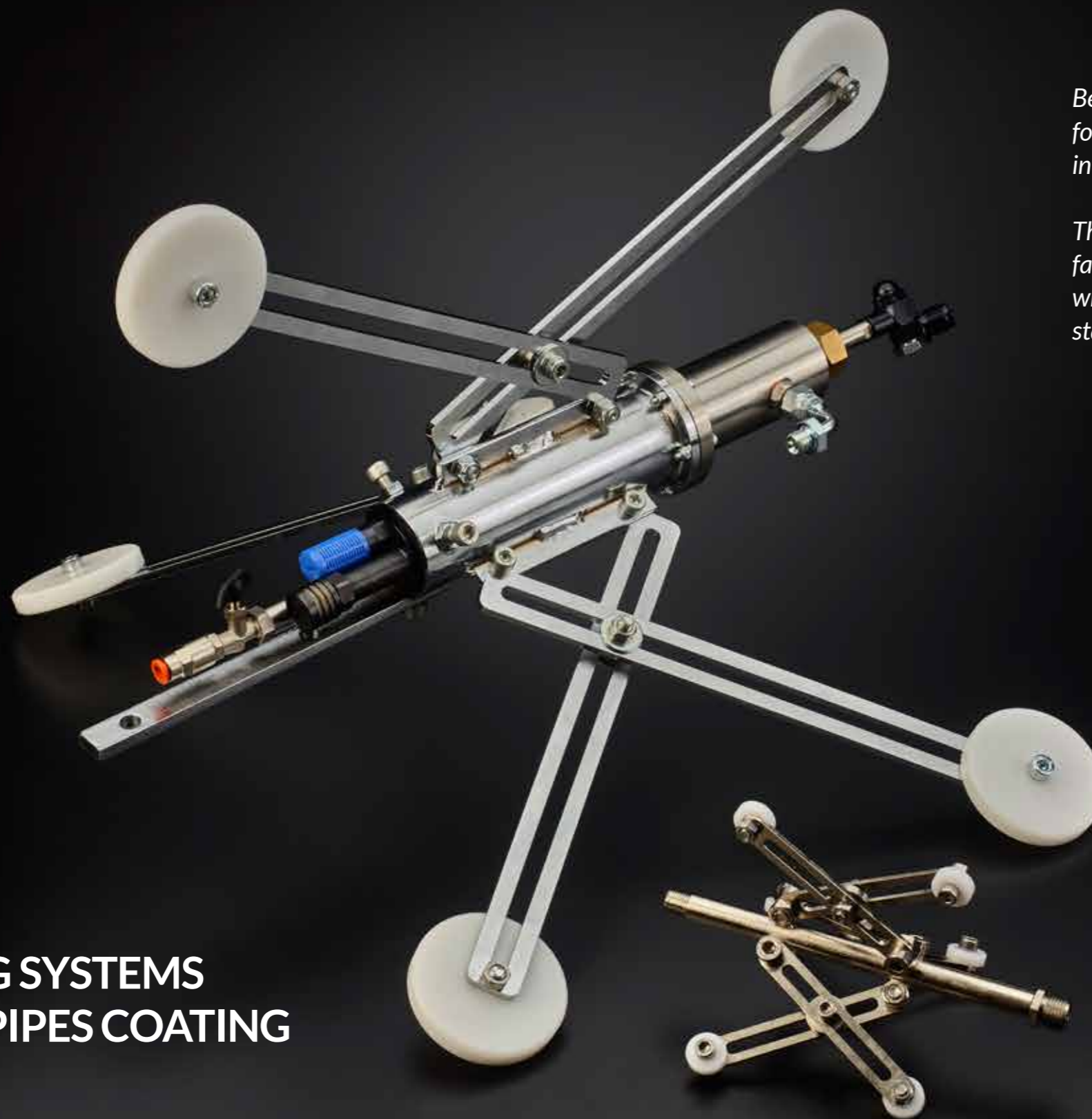

*Berizzi produces and supplies professional guns for high pressure airless spray painting, ideal for internal painting of pipes.*

*These painting systems are designed and manufactured with a compact and robust gun body, while all parts in contact with the material are in stainless steel.*



## PNEUS

Airless high pressure spray gun ideal for internal painting of pipes. These painting systems are designed and manufactured with a compact and robust gun body, while all parts in contact with the material are in stainless steel. It can work with pipe from a minimum diameter of 450mm to a maximum of 750mm or 1200mm depending on the version. On request it is possible to stretch the arms up to client's request. Pneus has a rotating pneumatic motor, which allows the continuous rotation of the nozzle, ensuring the complete coating of the inner surface of the pipe. 400 Bar. Available standard nozzles and extensions cable.

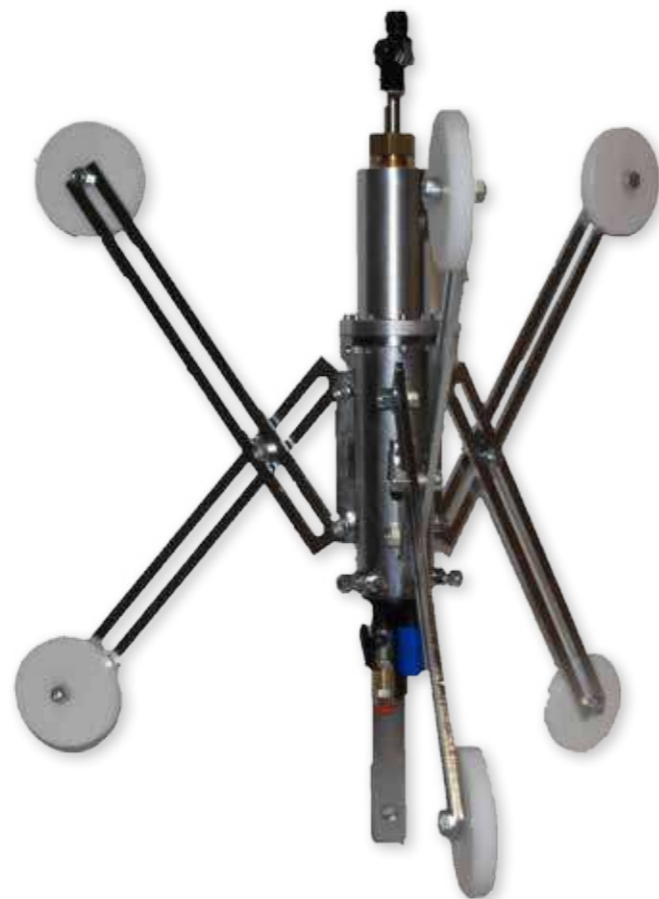

### TECHNICAL SPECIFICATIONS

PRES. MAX	400 bar/5800 psi
WEIGHT	7,5 Kg

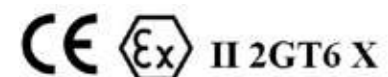

CODE	DESCRIPTION	Ø max.
TT80000	TK PNEUS airless gun with rotating arms L320	750mm
TT80001	TK PNEUS airless gun with rotating arms L700	1200mm

## PNEUS MINI

Airless high pressure spray gun ideal for internal painting of pipes. These painting systems are designed and manufactured with a compact and robust gun body, while all parts in contact with the material are in stainless steel. It can work with pipe from a minimum diameter of 40mm to a maximum of 200mm. Moreover, thanks to the 360° nozzle, the Pneus Mini is able to cover, in only one passage, the complete inner surface of the pipe. 400 Bar.



### TECHNICAL SPECIFICATIONS

PRES. MAX	400 bar/5800 psi
WEIGHT	410 gr

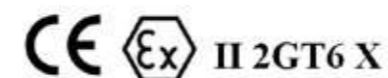

CODE	DESCRIPTION
TT80100	PNEUS MINI airless gun for internal pipes coating
TT801100A	PNEUS MINI airless for internal pipes coating with 360° nozzle
360XXX	360° nozzle

Sizes suggested for the 360° nozzle are: 11/110 - 13/110 - 15/110

## PAINT SPRAYING FILTERS

Berizzi produces and supplies high-quality *spray painting filters* at competitive prices, compatible with the products of the main brands available on the market.

Berizzi filters are made internally in different metal alloys and with various plastic materials, in different types and sizes of filtering net according to the specific application of the product used. Application: airless and air-assisted airless paint spraying guns, pumps and paint spraying equipment.



GUN FILTERS	page 82
INLINE STRAINERS	page 84
CUP FILTERS - LOW PRESSURE	page 90
SUCTION FILTERS	page 92
TIP FILTERS	page 96
DISC FILTERS	page 99
STRAINER FILTERS	page 101
MIXING	page 102
FOR GLUE APPLICATION	page 103

# PAINT SPRAYING FILTERS

## GUN FILTERS



PACK OF 100 PCS

CODE	DESCRIPTION	MESH	OEM REF.
FM2001	Green gun filter	30	0089323
FM2002	White gun filter	50	0034377
FM2003	Black gun filter	75	
FM2004	Yellow gun filter	100	0043235
FM2005	Blue gun filter	150	
FM2006	Red gun filter	200	0034383
FM2018	Silver gun filter	300	

COMPATIBLE with WAGNER and most of the airless spray guns

CODE	DESCRIPTION	MESH
FM2045	White gun filter	50
FM2046	Yellow gun filter	100
FM2047	Blue gun filter	150
FM2048	Red gun filter	200

COMPATIBLE with WAGNER

CODE	DESCRIPTION	MESH	OEM REF.
FM2015	Black gun filter type Graco	60	287032
FM2016	Blue gun filter type Graco	100	287033
FM2017	Orange gun filter type Graco	150	
FM2019	Grey gun filter type Graco	30	257129

COMPATIBLE with GRACO

CODE	DESCRIPTION	MESH	OEM REF.
FM2013	Blue gun filter type Graco	50	218131
FM2014	Orange gun filter type Graco	100	218133

COMPATIBLE with GRACO

## GUN FILTERS



PACK OF 5 PCS

CODE	DESCRIPTION	MESH	OEM REF.
FM2009	Green gun filter type Titan	30	540-030
FM2010	White gun filter type Titan	50	540-060
FM2011	Yellow gun filter type Titan	100	540-100
FM2012	Red gun filter type Titan	150	540-150

COMPATIBLE with TITAN



PACK OF 50 PCS

CODE	DESCRIPTION	MESH	OEM REF.
FM2101	Green gun filter type Optima	50	
FM2102	White gun filter type Optima	80	9995613
FM2103	Yellow gun filter type Optima	150	9995612
FM2104	Red gun filter type Optima	295	9995611

COMPATIBLE with OPTIMA



PACK OF 10 PCS

CODE	DESCRIPTION	MESH	OEM REF.
FM2007	Red gun filter type Iwata	50	3860120
FM2008	Yellow gun filter type Iwata	100	3860100

COMPATIBLE with ANEST IWATA

# PAINT SPRAYING FILTERS

## INLINE STRAINERS



PACK OF 25 PCS

CODE	DESCRIPTION	MESH	OEM REF.
FM2200	Inline strainer type Graco	15	646628
FM2201	Inline strainer type Graco	30	224458
FM2202	Inline strainer type Graco	60	224459
FM2203	Inline strainer type Graco	100	224468
FM2204	Inline strainer type Graco	150	162760
FM2205	Inline strainer type Graco	200	224469
FM2209	Inline strainer type Graco	300	162744
FM2210	Inline strainer type Graco	400	646628
FM2211	Inline strainer type Graco	500	467782
FM2212	Inline strainer type Graco	600	162787

Ø26,5 H144mm

COMPATIBLE with GRACO

CODE	DESCRIPTION	MESH
FM2201B	Inline strainer without flap	30
FM2202B	Inline strainer without flap	60
FM2203B	Inline strainer without flap	100
FM2204B	Inline strainer without flap	150
FM2205B	Inline strainer without flap	200

Ø26,5 H144mm

CODE	DESCRIPTION	MESH	OEM REF.
FM2020	Grey inline strainer type Graco	30	244071
FM2031	Yellow inline strainer type Graco	50	25A465
FM2021	Black inline strainer type Graco	60	244067
FM2022	Blue inline strainer type Graco	100	244068
FM2023	Red inline strainer type Graco	200	244069

Ø31 H180mm

COMPATIBLE with GRACO

CODE	DESCRIPTION	MESH	OEM REF.
FM2024	Black inline strainer type Graco	60	243080
FM2025	Blue inline strainer type Graco	100	243081
FM2026	Red inline strainer type Graco	200	243226

Ø31 H114mm

COMPATIBLE with GRACO



PACK OF 25 PCS



PACK OF 2 PCS



PACK OF 1 PC

## INLINE STRAINERS



PACK OF 2 PCS



PACK OF 25 PCS



PACK OF 25 PCS



PACK OF 25 PCS

CODE	DESCRIPTION	MESH	OEM REF.
FM2027	Grey inline strainer type Graco	30	246425
FM2028	Black inline strainer type Graco	60	246384
FM2029	Blue inline strainer type Graco	100	246382
FM2030	Red inline strainer type Graco	200	246383

Ø20 H91mm

COMPATIBLE with GRACO

CODE	DESCRIPTION	MESH	OEM REF.
FM2301	Mini inline strainer type Graco	30	236495
FM2302	Mini inline strainer type Graco	60	236496
FM2303	Mini inline strainer type Graco	100	236497
FM2304	Mini inline strainer type Graco	150	
FM2305	Mini inline strainer type Graco	200	236498

Ø26,5 H75mm

COMPATIBLE with GRACO

CODE	DESCRIPTION	MESH	OEM REF.
FM3701	Inline strainer type Wagner	20	0291564
FM3702	Inline strainer type Wagner	50	3514069
FM3703	Inline strainer type Wagner	100	3514068
FM3704	Inline strainer type Wagner	200	0295721

Ø27 H144mm

COMPATIBLE with WAGNER - PUMA

CODE	DESCRIPTION	MESH	OEM REF.
FM2501	Blue inline strainer type Colora	30	
FM2502	Black inline strainer type Colora	60	3811777
FM2503	Yellow inline strainer type Colora	100	3811778
FM2504	Red inline strainer type Colora	150	3811779
FM2505	White inline strainer type Colora	200	3811180
FM2506	Orange inline strainer type Colora	300	

Ø25 H155mm

COMPATIBLE with COLORA - WAGNER

# PAINT SPRAYING FILTERS

## INLINE STRAINERS



PACK OF 5 PCS

CODE	DESCRIPTION	MESH	OEM REF.
FM3501	Inline strainer type Wagner	30	0097 540
FM3502	Inline strainer type Wagner	60	0097 539
FM3503	Inline strainer type Wagner	100	0097 536
FM3504	Inline strainer type Wagner	200	0097 537
FM3505	Inline strainer type Wagner	250	0097 538

**Ø27 H114mm**

COMPATIBLE with WAGNER



PACK OF 25 PCS

CODE	DESCRIPTION	MESH	WAGNER	TITAN
FM3520	Inline strainer	30	508451	730-067-30
FM3521	Inline strainer	60	508748	730-067
FM3522	Inline strainer	100	508452	730067-10

**Ø21 H144mm**

COMPATIBLE with WAGNER-TITAN



CODE	DESCRIPTION	MESH	OEM REF.
FM27030	Blue suction filter C	30	
FM27060	Black suction filter C	60	3811 777
FM27100	White suction filter C	100	3811 778
FM27150	Red suction filter C	150	3811 778

COMPATIBLE with WAGNER ZIP



PACK OF 5 PCS

CODE	DESCRIPTION	MESH	OEM REF.
FM2410	Inline strainer type Kremlin 1	325	000.161.101
FM2409	Inline strainer type Kremlin 2	200	000.161.102
FM2408	Inline strainer type Kremlin 3	170	000.161.103
FM2407	Inline strainer type Kremlin 4	140	000.161.104
FM2411	Inline strainer type Kremlin 5	100	
FM2406	Inline strainer type Kremlin 6	85	000.161.106
FM2405	Inline strainer type Kremlin 8	70	000.161.108
FM2412	Inline strainer type Kremlin 9	60	
FM2404	Inline strainer type Kremlin 12	55	000.161.112
FM2403	Inline strainer type Kremlin 15	45	000.161.115
FM2402	Inline strainer type Kremlin 20	30	000.161.020
FM2401	Inline strainer type Kremlin 30	20	000.161.030

**Ø27 H115mm**

COMPATIBLE with KREMLIN

## INLINE STRAINERS



PACK OF 25 PCS

CODE	DESCRIPTION	MESH	OEM REF.
FM2701	Blue mini inline strainer type Wiwa	30	463779
FM2702	Orange mini inline strainer type Wiwa	50	163023
FM2703	Yellow mini inline strainer type Wiwa	70	160601
FM2704	Black mini inline strainer type Wiwa	100	160059
FM2705	Red mini inline strainer type Wiwa	150	160628
FM2706	White mini inline strainer type Wiwa	200	160636

**Ø26 H53mm**

COMPATIBLE with WIWA - BINKS



PACK OF 5 PCS

CODE	DESCRIPTION	MESH	OEM REF.
FM2600A	Green maxi inline strainer type Wiwa	20	0646628
FM2601	Blue maxi inline strainer type Wiwa	30	0467782
FM2602	Orange maxi inline strainer type Wiwa	50	0162787
FM2603	Yellow maxi inline strainer type Wiwa	70	0162779
FM2604	Black maxi inline strainer type Wiwa	100	0162760
FM2605	Red maxi inline strainer type Wiwa	150	0162752
FM2606	White maxi inline strainer type Wiwa	200	0162744

**Ø33,5 H130mm**

COMPATIBLE with WIWA - BINKS



PACK OF 5 PCS

CODE	DESCRIPTION	MESH	OEM REF.
FM3201	Inline strainer type II	50	0110-009058
FM3202	Inline strainer type II	100	0110-009075
FM3203	Inline strainer type II	150	0110-009059
FM3204	Inline strainer type II	200	0110-009060

**Ø32 H61,5mm**

COMPATIBLE with BINKS



PACK OF 5 PCS

CODE	DESCRIPTION	MESH	OEM REF.
FM3101	Inline strainer type III	50	0110-009131
FM3102	Inline strainer type III	100	0110-009132
FM3103	Inline strainer type III	150	0110-009133
FM3104	Inline strainer type III	200	0110-009234

**Ø32 H99,5mm**

COMPATIBLE with BINKS

# PAINT SPRAYING FILTERS

## INLINE STRAINERS



PACK OF 1 PCS

CODE	DESCRIPTION	MESH	OEM REF.
FM3303	Cartridge Filter type Binks	50	83-2089
FM3305	Cartridge Filter type Binks Ø19 H42mm	100	83-1256

COMPATIBLE with BINKS



PACK OF 5 PCS

CODE	DESCRIPTION	MESH	OEM REF.
FM3801	Inline strainer type Nordson	250	161102
FM3802	Inline strainer type Nordson	200	161103
FM3803	Inline strainer type Nordson	140	161104
FM3804	Inline strainer type Nordson	100	161106
FM3805	Inline strainer type Nordson	60	161109
FM3806	Inline strainer type Nordson	50	161112
FM3807	Inline strainer type Nordson	40	161115
FM3808	Inline strainer type Nordson Ø27 H114mm	30	161120

COMPATIBLE with NORDSON



PACK OF 5 PCS

CODE	DESCRIPTION	MESH	OEM REF.
FM3901	Inline strainer type Delon	60	
FM3902	Inline strainer type Delon Ø22 H100mm	100	83660009

COMPATIBLE with DELON

## INLINE STRAINERS



PACK OF 5 PCS

CODE	DESCRIPTION	MESH	OEM REF.
FM3601	Inline strainer type Böllhoff Nr. 20	20	0097 540
FM3602	Inline strainer type Böllhoff Nr. 15	30	0097 539
FM3603	Inline strainer type Böllhoff Nr.12	50	0097 536
FM3604	Inline strainer type Böllhoff Nr. 9	60	0097 537
FM3605	Inline strainer type Böllhoff Nr. 6	80	0097 538
FM3606	Inline strainer type Böllhoff Nr. 5	100	
FM3607	Inline strainer type Böllhoff Nr. 4	165	
FM3608	Inline strainer type Böllhoff Nr. 3	180	
FM3609	Inline strainer type Böllhoff Nr. 2	200	
FM3610	Inline strainer type Böllhoff Nr. 1 Ø27 H114mm	250	

COMPATIBLE with BÖLLHOFF



PACK OF 25 PCS

CODE	DESCRIPTION	MESH
FM2206	Inline strainer type VR	60
FM2207	Inline strainer type VR	100
FM2208	Inline strainer type VR Ø26,5 H115mm	200

COMPATIBLE with VR PUMP



CODE	DESCRIPTION	MESH
FM4001	Inline strainer type Iwata	60
FM4002	Inline strainer type Iwata Ø20 H80mm	100

COMPATIBLE with IWATA



CODE	DESCRIPTION	OEM REF.	POS.
FM3400	S.steel spring ø21 H122mm Kremlin	055.190.005	1
FM3401	S.steel spring ø22 H140mm Wagner	9894245	2
300006R	Nylon core for s.steel strainer type Graco	186075	3
300003R	Aluminium core for s.steel strainer type Graco	171939	4
300003T	Aluminium core for s.steel strainer without insert		5
FM620020	Aluminium core H75mm		6
FM620021	Aluminium core H114mm type Graco		7

# PAINT SPRAYING FILTERS

## CUP FILTERS - LOW PRESSURE



PACK OF 25 PCS

CODE	DESCRIPTION	MESH
FM2916	Nylon filter with nylon screen ø19mm	80
FM2917	Nylon filter with s. steel screen ø19mm	100
Insert: Ø8		



PACK OF 10 PCS

CODE	DESCRIPTION	MICRON	OEM REF.
FM2923	Green nylon filter with nylon screen	60	VSA-3
FM2924	Blue nylon filter with nylon screen	112	VSA-4
FM2925	White nylon filter with nylon screen	280	VSA-5

COMPATIBLE with DEVILBISS

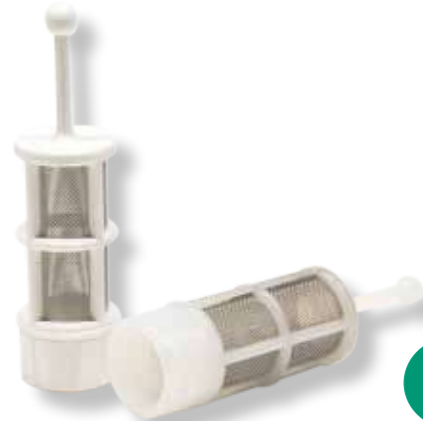

PACK OF 25 PCS

CODE	DESCRIPTION	MESH
FM2920	Nylon filter with s. steel screen ø19mm	60
Insert: Ø19		



PACK OF 25 PCS

CODE	DESCRIPTION	MESH
FM2921	Nylon filter with s. steel screen ø19mm	60
FM2922	Nylon filter with nylon screen ø19mm	80
Insert: Ø8		

## CUP FILTERS - LOW PRESSURE



PACK OF 25 PCS

CODE	DESCRIPTION	MESH
FM2909	Nylon filter with nylon screen ø19mm	80
FM2910	Nylon filter with s. steel screen ø19mm	100

COMPATIBLE with BINKS, DEVILBISS, SATA



PACK OF 25 PCS

CODE	DESCRIPTION	MESH
FM2909A	Nylon filter with nylon screen ø19mm	80
FM2910A	Nylon filter with s. steel screen ø19mm	100

COMPATIBLE with BINKS, DEVILBISS, SATA



PACK OF 25 PCS

CODE	DESCRIPTION	MESH
FM2905	Bag filter	80
Stainless steel screen and nylon base		



PACK OF 25 PCS

CODE	DESCRIPTION	MESH
FM2907	Nylon filter ø29mm 5000m/c 150µ	130
FM2908	Stainless steel filter ø29mm 5000m/c 150µ	100

COMPATIBLE with BINKS, DEVILBISS, SATA



PACK OF 25 PCS

CODE	DESCRIPTION	MESH
FM2911	White nylon filter with s. steel screen	60
FM2911R	Red nylon filter with s. steel screen	60
FM2915	Blue nylon filter with s. steel screen	80
FM2911N	Nylon filter with nylon screen 600m/c 275µ	60

COMPATIBLE with BINKS, DEVILBISS, SATA

# PAINT SPRAYING FILTERS

## SUCTION FILTERS



CODE	DESCRIPTION	MESH
FM23900	Mini suction filter 28x1,5mm	15
FM23901	Mini suction filter 28x1,5mm	30
FM23902	Mini suction filter 28x1,5mm	60
FM23903	Mini suction filter 28x1,5mm	100
FM23908	Mini filter screen	15
FM23904	Mini filter screen	30
FM23905	Mini filter screen	60
FM23906	Mini filter screen	100
FM23907	Mini nylon filter support Ø55 H80mm	



CODE	DESCRIPTION	MESH
FM2902	Suction filter 28x1,5mm	15
FM2903	Suction filter 28x1,5mm	30
FM2904	Suction filter 28x1,5mm	60
FM29900	Stainless steel filter screen	15
FM29901	Stainless steel filter screen	30
FM29902	Stainless steel filter screen	60
FM29903	Stainless steel upper support	
FM29904	Stainless steel lower support Ø95 H100mm	



CODE	DESCRIPTION
FM61009	M adapter 28x1,5mm F 15x1mm
FM61010	M adapter 28x1,5mm F 1/2"
FM61011	M adapter 28x1,5mm F 3/4"
FM61012	M adapter 28x1,5mm F 1"
	<b>Stainless steel</b>



CODE	DESCRIPTION	MESH
FM3301	Suction scew plug 25x1mm	30

COMPATIBLE with WIWA Ø35 - BINKS

## SUCTION FILTERS



CODE	DESCRIPTION	MESH	OEM REF.
FM20915	Suction filter F18x1mm EOS 10-C18 / EOS 15-C25 / EOS 30-C25 Ø27 H32,5mm - Support and screen in stainless steel	15	149.596.052

COMPATIBLE with KREMLIN

CODE	DESCRIPTION	MESH	OEM REF.
FM19801	Suction filter F 1"	10	
FM19802	Suction filter F 1/2"	10	237675
FM19803	Suction filter F 3/4"	10	235004
FM19806	Suction filter F 28x1,5mm	10	
FM19807	Suction filter F 7/8"	10	246385
	Ø56 H50m - Support in nylon and screen in stainless steel		

COMPATIBLE with GRACO

CODE	DESCRIPTION	MESH	OEM KREMLIN	OEM GRACO
FM20910	Suction filter F 1"	10		189920
FM20901	Suction filter F 1"	15		181072
FM20902	Suction filter F 1/2"	15		181073
FM20903	Suction filter F 3/4"	15		183770
FM20904	Suction filter F 3/8"	15		
FM20905	Suction filter F 15x1mm	15		
FM20906	Suction filter F 28x1,5mm	15		
FM20907	Suction filter F 25x1mm	15	149.596.152	
FM21905	Suction filter F 15x1mm	30		
FM21906	Suction filter F 28x1,5mm	30		
FM21902	Suction filter F 1/2"	30		
FM21903	Suction filter F 3/4"	30		
FM21901	Suction filter F 1"	30		
FM21904	Suction filter F 3/8"	30		
FM21907	Suction filter F 25x1mm	30		
FM22901	Suction filter 1"	60		
FM22902	Suction filter F 1/2"	60		
FM22903	Suction filter 3/4"	60		
FM22904	Suction filter F 3/8"	60		
FM22905	Suction filter F 15x1mm	60		
FM22906	Suction filter F 28x1,5mm	60		
	Ø47 H40mm - Support and screen in stainless steel			



# PAINT SPRAYING FILTERS

## SUCTION FILTERS



CODE	DESCRIPTION	MESH
FM2761515	Stainless steel suction filter ø15mm	15
FM2763015	Stainless steel suction filter ø15mm	30
FM2766015	Stainless steel suction filter ø15mm	60
FM2761517	Stainless steel suction filter ø17mm	15
FM2763017	Stainless steel suction filter ø17mm	30
FM2766017	Stainless steel suction filter ø17mm	60
FM2761521	Stainless steel suction filter ø21mm	15
FM2763021	Stainless steel suction filter ø21mm	30
FM2766021	Stainless steel suction filter ø21mm	60

**PIPE: Ø15, Ø17, Ø21 H73mm**



CODE	DESCRIPTION	MESH
FM2741512	Stainless steel suction filter 1/2"	15
FM2743012	Stainless steel suction filter 1/2"	30
FM2746012	Stainless steel suction filter 1/2"	60
FM2741515	Stainless steel suction filter 15x1mm	15
FM2743015	Stainless steel suction filter 15x1mm	30
FM2746015	Stainless steel suction filter 15x1mm	60

**PIPE: 1/2" and 15x1 mm H61mm**



CODE	DESCRIPTION	MESH
FM2913	Suction pipe filter ø16	60



CODE	DESCRIPTION	MESH
FM60005	Kit suction housing F 15x1mm with filter	30
FM60004	Kit suction housing F 1/2" with filter	30
FM60003	Spring for housing ø87mm	
FM60002	Naked housing F 15x1mm	
FM60001	Naked housing F 1/2"	
FM3010	Nylon orange disc filter ø87mm (pack of 50 pcs)	30
FM3011	Nylon red disc filter ø87mm (pack of 50 pcs)	50
FM3012	Nylon white disc filter ø83mm (pack of 50 pcs)	100

## SUCTION FILTERS



CODE	DESCRIPTION
FM60008	Kit suction housing ø57mm F 1/2"
FM60009	Kit suction housing ø57mm F 15x1mm
FM60010	Kit suction housing ø57mm ø16mm
FM60011	Naked housing ø57mm F 1/2"
FM60012	Naked housing ø57mm F 15x1mm
FM60013	Naked housing ø57mm ø16mm
FM3403	Spring for housing ø57mm
FM30570XX	Stainless steel disc filter ø57mm

**Disc filter sizes available: 20, 30, 40, 50, 70, 100, 200 Mesh (page 99)**



CODE	DESCRIPTION
FM60007	Kit suction housing F 1" ø140mm
FM60006	Naked housing F 1" ø140mm
FM3402	Spring for housing ø140mm
FM300X	Stainless steel disc filter ø140mm

**Disc filter sizes available: 20, 30, 50, 70 Mesh (page 99)**

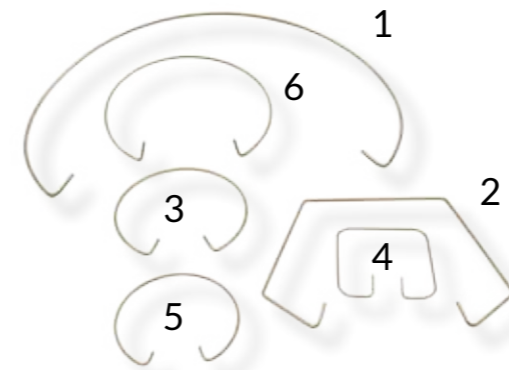

CODE	DESCRIPTION	POS.
FM3402	Spring for housing ø140mm	1
FM60003	Spring for housing ø87mm	2
FM3404	Spring for housing ø68mm	3
FM3405	Spring for housing ø52mm	4
FM3403	Spring for housing ø57mm	5
FM3406	Spring for gravity tank 20lt ø52mm	
FM61001	Spring for gravity tank 6lt ø87mm	6

# PAINT SPRAYING FILTERS

## TIP FILTERS



CODE	DESCRIPTION	MESH
FM2801B	Brass tip filter - complete	60
FM2802B	Brass tip filter - complete	100
FM2803B	Brass tip filter - complete	200
FM2804B	Brass support	
FM2807N	Nylon frame	



CODE	DESCRIPTION	MESH
FM2801S	Stainless steel tip filter - complete	60
FM2804S	Stainless steel tip filter - complete	75
FM2802S	Stainless steel tip filter - complete	100
FM2805S	Stainless steel tip filter - complete	150
FM2803S	Stainless steel tip filter - complete	200
FM2806S	Stainless steel support	
FM2807N	Nylon frame	



CODE	DESCRIPTION	MESH	OEM REF.
FM2804L	Red lamellar tip filter	30	
FM2801L	White lamellar tip filter	60	224454
FM2802L	Black lamellar tip filter	100	224453
FM2805L	Red lamellar tip filter	150	
FM2803L	Yellow lamellar tip filter	200	
FM2806L	Blue lamellar tip filter	300	

COMPATIBLE with GRACO



CODE	DESCRIPTION	MESH
FM2800N	Nylon tip filter - complete	30
FM2801N	Nylon tip filter - complete	60
FM2802N	Nylon tip filter - complete	100
FM2803N	Nylon tip filter - complete	200
FM28103	Tip filter screen	30
FM28104	Tip filter screen	60
FM28105	Tip filter screen	100
FM28106	Tip filter screen	200
	Stainless steel screen and nylon base	

PACK OF 100 PCS

## TIP FILTERS



CODE	DESCRIPTION	MESH	OEM REF.
FM2804	Tip filter screen	50	
FM28091	Tip filter screen	70	
FM2818	Tip filter screen Nr. 6	85	029.620.016
FM2805	Tip filter screen	100	
FM2817	Tip filter screen Nr. 4	140	029.620.008
FM2806	Tip filter screen Nr. 2	200	029.620.015
FM2816	Tip filter support		029.620.003
	Ø9,5 H11 mm		

COMPATIBLE with KREMLIN ATX



ONLY SCREEN

PACK OF 100 PCS

CODE	DESCRIPTION	MESH	OEM REF.
FM28050	Tip filter screen Nr .12	50	129.609.909
FM28060	Tip filter screen	60	
FM28071	Tip filter screen	75	
FM28075	Tip filter screen Nr. 6	85	129.609.908
FM28100	Tip filter screen	100	
FM28150	Tip filter screen Nr. 4	140	129.609.907
FM28081	Tip filter screen	150	
FM28200	Tip filter screen	200	
FM2814	Stainless steel tip filter support		029.520.310
	Ø9,5 H17,5 mm		

COMPATIBLE with KREMLIN AVX



PACK OF 10 PCS

CODE	DESCRIPTION	MESH	OEM REF.
FM2840	Tip filter type Graco	40	246357
FM2860	Tip filter type Graco	60	246358
FM2880	Tip filter type Graco	80	246359

COMPATIBLE with GRACO - MODELS FUSION CS - AP - MP

CODE	DESCRIPTION	MESH	OEM REF.
FM3020	Tip filter type Graco	20	180199
FM3080	Tip filter type Graco	80	255082

COMPATIBLE with GRACO - MODEL REACTOR

# PAINT SPRAYING FILTERS

## TIP FILTERS



PACK OF 100 PCS

CODE	DESCRIPTION	MESH	OEM REF.
FM2810	Tip filter for nozzle $\varnothing 7$ 99 $\mu$	140	129.609.901
FM2811	Tip filter for nozzle $\varnothing 7$ 260 $\mu$	75	
FM2813	Tip filter for nozzle $\varnothing 7$ 140 $\mu$	100	

COMPATIBLE with KREMLIN  $\varnothing 7$



PACK OF 100 PCS

CODE	DESCRIPTION	MESH	OEM REF.
FM2812	Tip filter for nozzle $\varnothing 9$	150	241804

COMPATIBLE with GRACO  $\varnothing 9$



CODE	DESCRIPTION	MESH
FM3019S	Stainless steel tip filter for ST nozzle	30
FM3016S	Stainless steel tip filter for ST nozzle	50
FM3017S	Stainless steel tip filter for ST nozzle	100
FM3018S	Stainless steel tip filter for ST nozzle	200

**$\varnothing 15$**

## DISC FILTERS



CODE	DESCRIPTION	MESH
FM3057020	Stainless steel disc filter $\varnothing 57$ mm single screen	20
FM3057030	Stainless steel disc filter $\varnothing 57$ mm single screen	30
FM3057040	Stainless steel disc filter $\varnothing 57$ mm single screen	40
FM3057050	Stainless steel disc filter $\varnothing 57$ mm single screen	50
FM3057070	Stainless steel disc filter $\varnothing 57$ mm single screen	70
FM3057100	Stainless steel disc filter $\varnothing 57$ mm single screen	100
FM3057200	Stainless steel disc filter $\varnothing 57$ mm single screen	200
FM3059020	Stainless steel disc filter $\varnothing 59$ mm single screen	20
FM3059030	Stainless steel disc filter $\varnothing 59$ mm double screen	30
FM3059050	Stainless steel disc filter $\varnothing 57$ mm single screen	50
FM3059070	Stainless steel disc filter $\varnothing 57$ mm single screen	70
FM3059100	Stainless steel disc filter $\varnothing 57$ mm single screen	100



CODE	DESCRIPTION	MESH
FM3014S	Stainless steel disc filter $\varnothing 51$ mm	20
FM3015S	Stainless steel disc filter $\varnothing 51$ mm	40

**$\varnothing 51$  Stainless steel screen and support**



CODE	DESCRIPTION	MESH
FM3004N	Stainless steel and nylon disc filter $\varnothing 87$ mm	50
FM3006N	Stainless steel and nylon disc filter $\varnothing 87$ mm	30
FM3007N	Stainless steel and nylon disc filter $\varnothing 87$ mm	100
FM3005N	Stainless steel and nylon disc filter $\varnothing 83$ mm	100

**Nylon support and stainless steel screen**



CODE	DESCRIPTION	MESH
FM3006	Stainless steel disc filter $\varnothing 140$ mm single screen	20
FM3007	Stainless steel disc filter $\varnothing 140$ mm double screen	30
FM3008	Stainless steel disc filter $\varnothing 140$ mm double screen	50
FM3009	Stainless steel disc filter $\varnothing 140$ mm double screen	70
FM3005	Stainless steel disc filter $\varnothing 140$ mm double screen	100

**Stainless steel screen and support**

# PAINT SPRAYING FILTERS

## DISC FILTERS



PACK OF 50 PCS

PACK OF 25 PCS

CODE	DESCRIPTION	MESH
FM3010	Orange nylon disc filter ø87mm	30
FM3011	Red nylon disc filter ø87mm	50
FM3012	White nylon disc filter ø83mm <b>Support and screen in nylon</b>	100



CODE	DESCRIPTION	MESH
FM3013	Disk filter for gravity tank 6 L <b>ø87,5mm - Support in nylon and screen in stainless steel</b>	20



CODE	DESCRIPTION
SL1000	White paint strainer 12,5x40cm 210µ (5 pcs)
SL4000	Yellow paint strainer 12,5x40cm 300µ (5 pcs)
SL9000	Paint strainer basket (1 pc)
SL4045	Paint strainer 40x45cm 300µ (3 pcs)

## STRAINER FILTERS



PACK OF 25 PCS

CODE	DESCRIPTION	MAGLIE
23500	Nylon paint strainer 60 Mesh 275 µm	500
23100	Nylon paint strainer 80 Mesh 210 µm	1000
23002	Nylon paint strainer 100 Mesh 160 µm	2000
23025	Nylon paint strainer 120 Mesh 140 µm	2500
23005	Nylon paint strainer 170 Mesh 90 µm	5000
23700	Nylon paint strainer 200 Mesh 80 µm	7000
23010	Nylon paint strainer 250 Mesh 60 µm	10000
23015	Nylon paint strainer 300 Mesh 45 µm	15000

**Ø filtration surface: 40mm**



PACK OF 10 PCS

CODE	DESCRIPTION	MAGLIE
FM20050	Green nylon strainer filter type Omnia 125µm	3000
FM20051	Blue nylon strainer filter type Omnia 195µm	1500
FM20052	White nylon strainer filter type Omnia 290µm	450

**Ø filtration surface: 90mm**



CODE	DESCRIPTION
23007	Red viscosity cup type Ford Ø4
23008	Yellow viscosity cup type Ford Ø4 with s. steel insert

# PAINT SPRAYING FILTERS

## MIXING



PACK OF 10 PCS

CODE	DESCRIPTION
FM2036	Stainless steel can opener L. 27cm Possibility to print the <u>company name</u>



PACK OF 500 PCS

CODE	DESCRIPTION
FM2037	Nylon paint stirrer L. 28cm
FM2039	Nylon paint stirrer L. 20cm Possibility to print the <u>company name</u>



CODE	DESCRIPTION
SCO001	Cleaning brush small L. 15cm
SCO002	Cleaning brush medium L. 28cm
SCO003	Cleaning brush big L. 37cm

## FOR GLUE APPLICATION



CODE	DESCRIPTION
FM39000	Filter for hot glue application EØ36, I ø29, H30mm



CODE	DESCRIPTION
FM39001	Filter for hot glue application EØ17, IØ14, H119mm

## SPRAY GUNS NOZZLES



Berizzi produces and supplies nozzles for air-assisted airless and airless paint spraying guns manufactured by the company and compatible with the products of the main brands in the field (Graco, Optima, Kremlin, Wagner).

The nozzles are made with special materials, extremely hard and compact with high precision technologies, in order to guarantee exceptional atomization quality and maximum durability.

AIR-ASSISTED AIRLESS  
AIRLESS

page 106  
page 111

# SPRAY GUNS NOZZLES

## AIR-ASSISTED AIRLESS



CODE	DESCRIPTION
TTUXXX	Mix Nozzle
KN001	Gasket

Example: For a tip with .011" and angle 30° order TTU311  
 Sizes available in the following table. More sizes available on request

IN	MM	Angle	.007	.009	.011	.013	.015	.017	.019	.021
2-4	(50-102)	10°	107	109	111					
4-6	(102-152)	20°	207	209	211	213	215	217	219	221
6-8	(152-203)	30°	307	309	311	313	315	317	319	321
8-10	(203-254)	40°		409	411	413	415	417	419	421
10-12	(254-305)	50°		509	511	513	515	517	519	521
12-14	(305-356)	60°		609	611	613	615	617	619	621
14-16	(356-406)	70°			711	713	715	717	719	721
16-18	(406-457)	80°					815	817	819	821
18-20	(457-508)	90°						917	919	921



CODE	DESCRIPTION
BNKXXX	Mix Nozzle type Binks

COMPATIBLE with BINKS

Example: For a tip with .011" and angle 30° order BNK311  
 Sizes available in the following table. More sizes available on request

IN	MM	Angle	.007	.009	.011	.013	.015	.017	.019	.021
2-4	(50-102)	10°	107	109	111					
4-6	(102-152)	20°	207	209	211	213	215	217	219	221
6-8	(152-203)	30°	307	309	311	313	315	317	319	321
8-10	(203-254)	40°		409	411	413	415	417	419	421
10-12	(254-305)	50°		509	511	513	515	517	519	521
12-14	(305-356)	60°		609	611	613	615	617	619	621
14-16	(356-406)	70°			711	713	715	717	719	721
16-18	(406-457)	80°					815	817	819	821
18-20	(457-508)	90°						917	919	921

## AIR-ASSISTED AIRLESS



CODE	DESCRIPTION
KKN4XX	Mix Nozzle type Kremlin
KKN2XX	Mix Nozzle type Kremlin with pre-orifice
KN001	Gasket

COMPATIBLE with KREMLIN

### KKN4XX

Example: For a tip with .011" and angle 30° order KKN06074  
 Sizes available in the following table. More sizes available on request

IN	MM	Angle	.007	.009	.011	.013	.015	.016	.019	.020
2-3	(50-90)	20°	03-034	04-034	06-034	09-034		14-034		
3-5	(90-130)	25°	03-054	04-054	06-054	09-054			18-054	
5-7	(130-170)	30°	03-074	04-074	06-074	09-074	12-074	14-074	18-074	20-074
7-8	(170-220)	40°		04-094	06-094	09-094	12-094	14-094	18-094	20-094
8-10	(220-270)	50°		04-114	06-114	09-114	12-114	14-114	18-114	20-114
10-11	(270-290)	55°		04-134	06-134	09-134	12-134	14-134	18-134	20-134
11-12	(290-320)	60°		04-154	06-154	09-154	12-154	14-154	18-154	20-154
12-14	(320-370)	70°			06-174	09-174	12-174	14-174	18-174	20-174
14-14	(370-450)	80°								20-194

### KKN2XX

Example: For a tip with .011" and angle 30° order KKN06072  
 Sizes available in the following table. More sizes available on request

IN	MM	Angle	.007	.009	.011	.013	.015	.016	0.19	.020
2-3	(50-90)	20°	03-032	04-032	06-032	09-032		14-032		
3-5	(90-130)	25°	03-052	04-052	06-052	09-052			18-052	
5-7	(130-170)	30°	03-072	04-072	06-072	09-072	12-072	14-072	18-072	20-072
7-8	(170-220)	40°		04-092	06-092	09-092	12-092	14-092	18-092	20-092
8-10	(220-270)	50°		04-112	06-112	09-112	12-112	14-112	18-112	20-112
10-11	(270-290)	55°		04-132	06-132	09-132	12-132	14-132	18-132	20-132
11-12	(290-320)	60°		04-152	06-152	09-152	12-152	14-152	18-152	20-152
12-14	(320-370)	70°					12-172	14-172	18-172	20-172
14-14	(370-450)	80°								20-192

# SPRAY GUNS NOZZLES

## AIR-ASSISTED AIRLESS



CODE	DESCRIPTION
GWNXXX	Mix Nozzle type Graco
GWN2XXX	Mix Nozzle type Graco with pre-orifice
GN001	Gasket

COMPATIBLE with GRACO

### GWNXXX

Example: For a tip with .011" and angle 30° order GWN311  
 Sizes available in the following table. More sizes available on request

IN	MM	Angle	.007	.009	.011	.013	.015	.017	.019	.021
2-4	(50-102)	10°	107	109	111					
4-6	(102-152)	20°	207	209	211	213	215	217	219	221
6-8	(152-203)	30°	307	309	311	313	315	317	319	321
8-10	(203-254)	40°		409	411	413	415	417	419	421
10-12	(254-305)	50°		509	511	513	515	517	519	521
12-14	(305-356)	60°		609	611	613	615	617	619	621
14-16	(356-406)	70°			711	713	715	717	719	721
16-18	(406-457)	80°					815	817	819	821
18-20	(457-508)	90°						917	919	921

### GWN2XXX

Example: For a tip with .010" and angle 30° order GWN2310  
 Sizes available in the following table. More sizes available on request

IN	MM	Angle	.008	.010	.012	.014	.016
4-6	(102-152)	20°	208	210	212		
6-8	(152-203)	30°	308	310	312		
8-10	(203-254)	40°	408	410	412	414	416
10-12	(254-305)	50°		510	512	514	516
12-14	(305-356)	60°		610	612	614	616
14-16	(356-406)	70°		710	712	714	716

## AIR-ASSISTED AIRLESS



CODE	DESCRIPTION
GNNXXX	Mix Nozzle type Graco

Compatible with Graco nozzles: AXM, AAM and GG4

COMPATIBLE with GRACO

Example: For a tip with .011" and angle 30° order GNN311  
 Sizes available in the following table. More sizes available on request

IN	MM	Angle	.007	.009	.011	.013	.015	.017	.019	.021
2-4	(50-102)	10°	107	109	111					
4-6	(102-152)	20°	207	209	211	213	215	217	219	221
6-8	(152-203)	30°	307	309	311	313	315	317	319	321
8-10	(203-254)	40°		409	411	413	415	417	419	421
10-12	(254-305)	50°		509	511	513	515	517	519	521
12-14	(305-356)	60°		609	611	613	615	617	619	621
14-16	(356-406)	70°			711	713	715	717	719	721
16-18	(406-457)	80°					815	817	819	821
18-20	(457-508)	90°						917	919	921



CODE	DESCRIPTION
GN2XXX	Mix Nozzle type Graco with pre-orifice

Compatible with Graco nozzles: AXF and AFF

COMPATIBLE with GRACO

Example: For a tip with .010" and angle 30° order GN2310  
 Sizes available in the following table. More sizes available on request

IN	MM	Angle	.008	.010	.012	.014	.016
4-6	(102-152)	20°	208	210	212		
6-8	(152-203)	30°	308	310	312		
8-10	(203-254)	40°	408	410	412	414	416
10-12	(254-305)	50°		510	512	514	516
12-14	(305-356)	60°		610	612	614	616
14-16	(356-406)	70°		710	712	714	716



# SPRAY GUNS NOZZLES

## AIR-ASSISTED AIRLESS



CODE	DESCRIPTION
WGMXXX	Mix Nozzle type Wagner

COMPATIBLE with WAGNER

Example: For a tip with .011" and angle 30° order WGM311  
 Sizes available in the following table. More sizes available on request

IN	MM	Angle	.007	.009	.011	.013	.015	.017	.019	.021
2-4	(50-102)	10°	107	109	111					
4-6	(102-152)	20°	207	209	211	213	215	217	219	221
6-8	(152-203)	30°	307	309	311	313	315	317	319	321
8-10	(203-254)	40°		409	411	413	415	417	419	421
10-12	(254-305)	50°		509	511	513	515	517	519	521
12-14	(305-356)	60°		609	611	613	615	617	619	621
14-16	(356-406)	70°			711	713	715	717	719	721
16-18	(406-457)	80°					815	817	819	821
18-20	(457-508)	90°						917	919	921



CODE	DESCRIPTION
WGM2XXX	Mix Nozzle type Wagner with pre-orifice

COMPATIBLE with WAGNER

Example: For a tip with .010" and angle 30° order WGM2310  
 Sizes available in the following table. More sizes available on request

IN	MM	Angle	.008	.010	.012	.014	.016
4-6	(102-152)	20°	208	210	212		
6-8	(152-203)	30°	308	310	312		
8-10	(203-254)	40°	408	410	412	414	416
10-12	(254-305)	50°		510	512	514	516
12-14	(305-356)	60°		610	612	614	616
14-16	(356-406)	70°		710	712	714	716

## AIR-ASSISTED AIRLESS



CODE	DESCRIPTION
OPNXXX	Mix Nozzle type Optima 2100
ON001N	Gasket

COMPATIBLE with OPTIMA 21

Example: For a tip with .028" and angle 30° order OPN328  
 Sizes available in the following table. More sizes available on request

IN	MM	Angle	0.18 <sub>0.007</sub>	0.23 <sub>.009</sub>	0.28 <sub>0.011</sub>	0.33 <sub>0.013</sub>	0.38 <sub>0.015</sub>	0.43 <sub>0.017</sub>	.048 <sub>0.019</sub>	.053 <sub>0.021</sub>
4-6	(102-152)	20°	218	223	228	233	238	243	248	253
6-8	(152-203)	30°	318	323	328	333	338	343	348	353
8-10	(203-254)	40°	418	423	428	433	438	443	448	453
10-12	(254-305)	50°	518	523	528	533	538	543	548	553
12-14	(305-356)	60°	618	623	628	633	638	643	648	653



CODE	DESCRIPTION
ONXXX	Mix Nozzle type Optima 2000
102003	Gasket

COMPATIBLE with OPTIMA 20

Example: For a tip with .028" and angle 30° order ON328  
 Sizes available in the following table. More sizes available on request

IN	MM	Angle	0.18 <sub>0.007</sub>	0.23 <sub>.009</sub>	0.28 <sub>0.011</sub>	0.33 <sub>0.013</sub>	0.38 <sub>0.015</sub>	0.43 <sub>0.017</sub>	.048 <sub>0.019</sub>	.053 <sub>0.021</sub>
4-6	(102-152)	20°	218	223	228	233	238	243	248	253
6-8	(152-203)	30°	318	323	328	333	338	343	348	353
8-10	(203-254)	40°	418	423	428	433	438	443	448	453
10-12	(254-305)	50°	518	523	528	533	538	543	548	553
12-14	(305-356)	60°	618	623	628	633	638	643	648	653

# SPRAY GUNS NOZZLES

## AIRLESS



CODE	DESCRIPTION
STXXX	Standard Nozzle
100030	ST Nozzle gasket

Example: For a tip with .011" and angle 30° order ST311  
 Sizes available in the following table. More sizes available on request

IN	MM	A°	.007	.009	.011	.013	.015	.017	.019	.021	.023	.025	.027	.029	.031	.033	.035	.037	.039	.041	.043	.045	.047	.049	.051	.053	.055	.063	.065
2-4	(50-102)	10°	107	109	111	113	115	117																					
4-6	(102-152)	20°	207	209	211	213	215	217	219	221	223	225																	
6-8	(152-203)	30°	307	309	311	313	315	317	319	321	323	325	327	329	331	333	335	337	339	341	343								
8-10	(203-254)	40°	407	409	411	413	415	417	419	421	423	425	427	429	431	433	435	437	439	441	443	445	447	449	451	453	455	463	465
10-12	(254-305)	50°		509	511	513	515	517	519	521	523	525	527	529	531	533	535	537	539	541	543	545	547	549	551	553	555	563	565
12-14	(305-356)	60°		609	611	613	615	617	619	621	623	625	627	629	631	633	635	637	639	641	643	645	647	649	651	653	655	663	665
14-16	(356-406)	70°				713	715	717	719	721	723	725	727	729	731	733	735	737	739	741	743	745	747	749	751	753	755	763	765
16-18	(406-457)	80°				813	815	817	819	821	823	825	827	829	831	833	835	837	839	841	843								
18-20	(457-508)	90°						917	919	921	923	925	927	929	931	933	935	937	939	941	943								



CODE	DESCRIPTION
STFXXX	Standard STF nozzle Berizzi
100030	ST Nozzle gasket

Thanks to its particular manufacturing process, this nozzle guarantees a better finishing compared to the classic standards available on the market.

Example: For a tip with .011" and angle 30° order STF311  
 Sizes available in the following table. More sizes available on request

IN	MM	A°	.007	.009	.011	.013	.015	.017	.019	.021	.023	.025	.027	.029	.031	.033	.035	.037	.039	.041	.043	.045	.047	.049	.051	.053	.055	.063	.065
2-4	(50-102)	10°	107	109	111	113	115	117																					
4-6	(102-152)	20°	207	209	211	213	215	217	219	221	223	225																	
6-8	(152-203)	30°	307	309	311	313	315	317	319	321	323	325	327	329	331	333	335	337	339	341	343								
8-10	(203-254)	40°	407	409	411	413	415	417	419	421	423	425	427	429	431	433	435	437	439	441	443	445	447	449	451	453	455	463	465
10-12	(254-305)	50°		509	511	513	515	517	519	521	523	525	527	529	531	533	535	537	539	541	543	545	547	549	551	553	555	563	565
12-14	(305-356)	60°		609	611	613	615	617	619	621	623	625	627	629	631	633	635	637	639	641	643	645	647	649	651	653	655	663	665
14-16	(356-406)	70°			711	713	715	717	719	721	723	725	727	729	731	733	735	737	739	741	743	745	747	749	751	753	755	763	765
16-18	(406-457)	80°			811	813	815	817	819	821	823	825	827	829	831	833	835	837	839	841	843								
18-20	(457-508)	90°						917	919	921	923	925	927	929	931	933	935	937	939	941	943								

## AIRLESS



CODE	DESCRIPTION
FFXXX	Fine finish standard nozzle Berizzi

Thanks to its doubleinsert and the calibrated pre-atomizers, this nozzle is made for an **exceptional finishing** compared to the classic fine finish nozzles.

Example: For a tip with .010" and angle 30° order FF310  
 Sizes available in the following table. More sizes available on request

IN	MM	Angle	.008	.010	.012	.014	.016	.018	.020	.022	.024	.026	.028	.030	.032
2-4	(50-102)	10°	108	110											
4-6	(102-152)	20°	208	210	212	214	216	218			224				232
6-8	(152-203)	30°	308	310	312	314	316	318							
8-10	(203-254)	40°	408	410	412	414	416	418	420				428	430	432
10-12	(254-305)	50°	508	510	512	514	516	518	520	522			528	530	
12-14	(305-356)	60°	608	610	612	614	616	618	620	622	624	626	628		
14-16	(356-406)	70°	708	710	712	714	716	718							
16-18	(406-457)	80°	808	810	812	814	816	818	820	822	824	826	828		832
18-20	(457-508)	90°			912	914		918			924	926			



CODE	DESCRIPTION
FIXXXX	Fine finish nozzle type Graco

**GRACO PRODUCT**

Example: For a tip with .010" and angle 30° order FIX310  
 Sizes available in the following table. More sizes available on request

IN	MM	Angle	.008	.010	.012	.014	.016	.018	.020	.022	.024	.026	.028	.030	.032
2-4	(50-102)	10°	108												
4-6	(102-152)	20°	208	210	212	214	216	218			224				232
6-8	(152-203)	30°		310	312	314	316	318							
8-10	(203-254)	40°	408	410	412	414	416	418	420				428	430	432
10-12	(254-305)	50°		510	512	514	516	518	520	522			528	530	
12-14	(305-356)	60°		610	612	614	616	618	620	622	624	626			
14-16	(356-406)	70°			712	714	716	718							
16-18	(406-457)	80°				814	816	818	820	822	824	826	828		832
18-20	(457-508)	90°			912	914		918			924				

# SPRAY GUNS NOZZLES

## AIRLESS



CODE	DESCRIPTION
FM6XXX	Reversible FM6 Tip
201204	Tip guard repair kit

**COMPATIBLE** with tip guards: TITAN SC6, TITAN SCF, WAGNER and GRACO RAC V

Example: For a tip with .011" and angle 30° order FM6311  
 Sizes available in the following table. More sizes available on request

IN	MM	A°	.007	.009	.011	.013	.015	.017	.019	.021	.023	.025	.027	.029	.031	.033	.035	.037	.039	.041	.043	.045	.047	.049	.051	.053	.055	.063	.065		
2-4	(50-102)	10°	109	111	113	115	117																								
4-6	(102-152)	20°	207	209	211	213	215	217	219	221	223	225																			
6-8	(152-203)	30°	307	309	311	313	315	317	319	321	323	325	327	329	331	333	335	337	339	341	343										
8-10	(203-254)	40°	407	409	411	413	415	417	419	421	423	425	427	429	431	433	435	437	439	441	443	445	447	449	451	453	455		465		
10-12	(254-305)	50°	509	511	513	515	517	519	521	523	525	527	529	531	533	535		539	541	543	545	547	549	551	553	555	563	565			
12-14	(305-356)	60°	609	611	613	615	617	619	621	623	625	627	629	631	633	635		639	641	643	645	647	649	651	653	655	663	665			
14-16	(356-406)	70°																													
16-18	(406-457)	80°			813	815	817	819	821	823	825	827	829	831	833	835		839	841	843											
18-20	(457-508)	90°					917	919	921	923	925	927	929	931	933	935		939	941	943											

## AIRLESS



CODE	DESCRIPTION
FMLMXXX	Reversible line marking FMLM tip
201204	Tip guard gasket

The airless reversible FMLM tip is designed for striping roads, parking lots, airport, athletic fields and interior floors of industrial warehouses. The spray pattern design results in sharp distinct lines with minimal overspray.

**COMPATIBLE** with tip guards: GRACO SwitchTip LineLazer RAC 5, TRITECH Sharp Liner Series, TITAN and WAGNER TR1 Line Striping tips

Example: For a tip with .013" and angle 20° order FMLM213  
 Sizes available in the following table. More sizes available on request

IN	MM	Angle	.013	.015	.017	.019	.021	.023	.025	.027	.029	.031	.035
4-6	(10-15)	20°	213	215	217	219							
6-8	(15-20)	30°		315	317	319	321	323	325	327	329	331	
8-10	(20-25.5)	40°			417	419	421	423	425	427	429	431	435
12-14	(30.5-35.5)	60°					621	623	625	627	629	631	635



CODE	DESCRIPTION
FMC6XXX	Reversible and preatomized FMC6 Tip
201204	Tip guard repair kit

**COMPATIBLE** with tip guards: TITAN SC6, TITAN SCF, WAGNER and GRACO RAC V

Example: For a tip with .010" and angle 30° order FMC6310  
 Sizes available in the following table. More sizes available on request

IN	MM	Angle	.008	.010	.012	.014	.016	.018
2-4	(5-10)	10°	108	110	112	114		
4-6	(10-15)	20°	208	210	212	214		
6-8	(15-20)	30°	308	310	312	314		
8-10	(20-25.5)	40°	408	410	412	414		
10-12	(25.5-30.5)	50°		510	512	514	516	518
12-14	(30.5-35.5)	60°			612	614	616	618

CODE	DESCRIPTION	OEM REF.
RACXXX	Reversible tip RAC 5	262XXX
201302	Repair kit RAC5 (Pack. of 5pcs)	

**GRACO PRODUCT**

Example: For a tip with .011" and angle 30° order RACV311  
 Sizes available in the following table. More sizes available on request

IN	MM	A°	.007	.009	.011	.013	.015	.017	.019	.021	.023	.025	.027	.029	.031	.033	.035	.039	.043	.045	.051	.055	.063	.065
2-4	(50-102)	10°	109	111	113	115		119																
4-6	(102-152)	20°	207	209	211	213	215	217	219	221	223	225					235							
6-8	(152-203)	30°	307	309	311	313	315	317	319	321	323	325	327		331									
8-10	(203-254)	40°	409	411	413	415	417	419	421	423	425	427	429	431	433	435	439	443		451	455			
10-12	(254-305)	50°	509	511	513	515	517	519	521	523	525	527	529	531	533	535		543		551	555	563		
12-14	(305-356)	60°	609	611	613	615	617	619	621	623	625	627	629	631	633	635		645		655		665		
14-16	(356-406)	70°							721	723	725		729				735							
16-18	(406-457)	80°				815	817	819	821			827			831	833	835							
18-20	(457-508)	90°					917										935							

# SPRAY GUNS NOZZLES

## AIRLESS



CODE	DESCRIPTION
201203	FM6 Tip guard 11/16"
201203G	FM6 Tip guard 7/8"
201204	Tip guard repair kit

COMPATIBLE with reversible tips: FM6, FMC6, TITAN SC6, WAGNER TRADE TIP3, TWIN TIP and GRACO RAC V



CODE	DESCRIPTION
201305	Tip guard for Mach3 spray gun
201204	Tip guard repair kit



CODE	DESCRIPTION	OEM REF.
201301	Tip guard RAC 5 11/16"	243263
201301G	Tip guard RAC 5 fitting G 7/8"	243161

### GRACO PRODUCT

COMPATIBLE with FM6 and FMC6 reversible tips

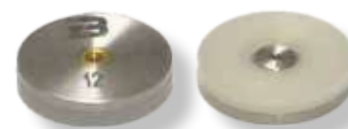

CODE	DESCRIPTION
201010	Pre-orifice M10
201012	Pre-orifice M12
201015	Pre-orifice M15
201018	Pre-orifice M18
201021	Pre-orifice M21
201026	Pre-orifice M26
201011	Pre-orifice gasket

## AIRLESS



CODE	DESCRIPTION	POS
360XXX	Nozzle 360° sistem for Pneus gun	1
360INS	Insert for 360° nozzle	2
GUARN360	Gasket insert for 360° nozzle	3
DAD360	Nut for 360° nozzle	4
BBS1713	Hole closure cup	5



CODE	DESCRIPTION
FM63018	Aluminium adapter F11/16" x M7/8"
FM63018I	Stainless steel adapter F11/16" x M7/8"
BBS1835	Stainless steel adapter F7/8" x M11/16"



CODE	DESCRIPTION
FM63020	Steel nut 11/16"
201403I	Stainless steel nut 11/16"
100031	Fingers guard 11/16"
100030	Gasket ST nozzle for nut 11/16"
FM63020G	Steel nut 7/8"
FM63020GI	Stainless steel nut 7/8"
400445R	Gasket ST nozzle for nut 7/8"



in ALUMINUM

CODE	DESCRIPTION
FM63017F	Complete Joint connector 11/16"
FM63017G	Complete Joint connector with G connection 7/8"
FM63022	Kit (3pcs) gaskets for joint FM63017
FM63023	Stainless steel holder screw for steel nut

# SPRAY GUNS NOZZLES

## AIRLESS



in STAINLESS STEEL

CODE	DESCRIPTION
FM63008F	Mini Extension cm 15 11/16"
FM63009F	Mini Extension cm 30 11/16"
FM63010F	Mini Extension cm 45 11/16"
FM63011F	Mini Extension cm 60 11/16"
FM63012F	Mini Extension cm 80 11/16"
FM63013F	Mini Extension cm 100 11/16"
FM63015F	Maxi Extension cm 100 11/16"
FM63014F	Maxi Extension cm 200 11/16"
FM63008G	Mini Extension cm 15 G connection 7/8"
FM63009G	Mini Extension cm 30 G connection 7/8"
FM63010G	Mini Extension cm 45 G connection 7/8"
FM63011G	Mini Extension cm 60 G connection 7/8"
FM63012G	Mini Extension cm 80 G connection 7/8"
FM63013G	Mini Extension cm 100 G connection 7/8"
FM63015G	Maxi Extension cm 100 G connection 7/8"
FM63014G	Maxi Extension cm 200 G connection 7/8"
FM63016	Gasket for adapter Ø11
FM63019	Stainless steel adapter F1/2 JIC x M7/8"
FM63021	Stainless steel adapter F1/2 JIC x M11/16"



in ANODIZED ALUMINUM

CODE	DESCRIPTION
TR66350	Joint connector for extension
TR66351	Kit extension joint connector
TR77730	Extension 300mm
TR77750	Extension 500mm
TR77830	Extension 300mm with joint connector
TR77850	Extension 500mm with joint connector



CODE	DESCRIPTION
100400	Roller kit F7/8" connection
100444	Roller
FM63018	Aluminum adapter F11/16" x M7/8"

## AIRLESS



CODE	DESCRIPTION
20150	Nozzles for silicones Ø1,5mm
20200	Nozzles for silicones Ø2mm



CODE	DESCRIPTION
200111	Cleaning needles L. 29 mm (12 pcs.)



CODE	DESCRIPTION
TR78625	Nozzle flat shape in stainless steel
TR78624	Nozzle Ø4,5mm in stainless steel
TR78623	Nozzle Ø6,5mm in stainless steel
TR78622	Nozzle Ø8,5mm in stainless steel
TR78621	Nozzle Ø10,5mm in stainless steel

Nozzles for manual gun for low pressure paint spraying

## FILTER HOLDERS

*Berizzi produces and supplies filter holders for paint spraying guns and spray systems produced by the company and compatible with the main brands in the field. Berizzi filter holders are manufactured with special materials, extremely hard and compact, processed with high precision technologies in order to guarantee exceptional quality and maximum durability.*



# FILTER HOLDERS



CODE	DESCRIPTION
FM63004	S. steel filter holder M 1/4" BSP x F 1/4" BSP
FM63005	S. steel filter holder M 1/4" BSP x F 3/8" BSP
FM63014	S. steel filter holder M 1/4" NPT x F 1/4" NPS
FM63015	S. steel filter holder M 1/4" BSP x F 1/4" NPT
FM63024	S. steel filter holder M 3/8" NPS x F 3/8" NPS

Press. max.: 500 Bar / 7250 Psi  
FM2802N - 100 Mesh filter included



CODE	DESCRIPTION
FM63032C	Short filter holder bended F 1/4" BSP x M 1/4" BSP

Press. max.: 500 Bar / 7250 Psi  
FM2802L - 100 Mesh filter included



CODE	DESCRIPTION
107300	S. steel assy inline filter M 1/4" NPS x F 1/4" NPS
107320	S. steel assy inline filter M 1/4" BSP x F 1/4" BSP
107325	S. steel assy inline filter M 3/8" NPS x F 3/8" NPS

Press. max.: 500 Bar / 7250 Psi  
FM2802N 100 Mesh filter included



CODE	DESCRIPTION
FM63050	S. steel filter holder F3/8" NPS x M3/8" NPS
FM63051	S. steel filter holder F3/8" NPS x M1/4" NPS
FM63060	S. steel filter holder F3/8" NPS x M3/8" BSP
FM63061	S. steel filter holder F3/8" NPS x M1/4" BSP

Press. max.: 15 Bar / 217 Psi



CODE	DESCRIPTION
107305	S. steel swivel with inline filter M 1/4" BSP x F 1/4" NPS
107310	S. steel swivel with inline filter M 1/4" NPS x F 1/4" NPS
107315	S. steel swivel with inline filter M 1/4" NPS x F 1/4" BSP
107316	S. steel swivel with inline filter M 1/4" BSP x F 1/4" BSP
107330	S. steel swivel with inline filter M 3/8" NPS x F 3/8" NPS

Press. max.: 500 Bar / 7250 Psi  
FM2802N - 100 Mesh filter included



CODE	DESCRIPTION
FM63033	Filter holder F 1/4" BSP x M 1/4" BSP
FM63034	Filter holder F 16x1,5mm x M 16x1,5mm
FM63035	Filter holder F 3/8" BSP x M 1/4" BSPmm

Press. max.: 500 Bar / 7250 Psi



CODE	DESCRIPTION
FM63006	Filter holder M 11/16" x F 11/16"
FM63007	Filter holder M 11/16" x F 7/8"
201403I	Stainless steel nut 11/16" for filter holder

Press. max.: 500 Bar / 7250 Psi  
FM2802N - 100 Mesh filter included



CODE	DESCRIPTION
FM65001	S. steel straight filter holder F 1/4" BSP x M 1/4" BSP
FM65031	S. steel straight filter holder F 3/8" BSP x M 1/4" BSP
302002R	Ptfe gasket

Press. max.: 500 Bar / 7250 Psi  
FM2046 - 100 Mesh filter included

# FILTER HOLDERS



CODE	DESCRIPTION
FM65001C	S. steel bended filter holder F 1/4" BSP x M 1/4" BSP
FM65031C	S. steel bended filter holder F 3/8" BSP x M 1/4" BSP
302002R	Ptfe gasket

Press. max.: 500 Bar / 7250 Psi  
**FM2046 - 100 Mesh filter included**



CODE	DESCRIPTION
FM63001C	S. steel bended filter holder F 1/4" BSP x M 1/4" BSP
FM63002C	S. steel bended filter holder F 1/4" BSP x M 3/8" BSP
FM63003C	S. steel bended filter holder F 3/8" BSP x M 3/8" BSP
FM63030C	S. steel bended filter holder F 1/4" BSP x M 16x1,5mm
FM63031C	S. steel bended filter holder F 3/8" BSP x M 1/4" BSP
301500	Spring for filter holder
302002R	Ptfe gasket

Press. max.: 500 Bar / 7250 Psi  
**FM2004 - 100 Mesh filter included**



CODE	DESCRIPTION
FM63052	Fixed spray gun connection fitting F 1/4" BSP x M 1/4" BSP
FM63054	Fixed spray gun connection fitting F 1/4" NPS x M 1/4" NPS
FM63053	Fixed spray gun connection fitting F 3/8" BSP x M 3/8" BSP
FM63055	Fixed spray gun connection fitting F 3/8" NPS x M 3/8" NPS

Press. max.: 500 Bar / 7250 Psi



CODE	DESCRIPTION
FM66001	S. steel straight filter holder F 1/4" BSP x M 1/4" BSP
FM66002	S. steel straight filter holder F 1/4" BSP x M 3/8" BSP
FM66003	S. steel straight filter holder F 3/8" BSP x M 3/8" BSP
FM66030	S. steel straight filter holder F 1/4" BSP x M 16x1,5mm
FM66031	S. steel straight filter holder F 3/8" BSP x M 1/4" BSP
FM66036	S. steel straight filter holder F 1/2" JIC x M 1/2" JIC
FM66037	S. steel straight filter holder F 1/2" JIC x M 1/4" BSP
FM66038	S. steel straight filter holder F 1/2" JIC x M 3/8" BSP
301500	Spring for filter holder
302002R	Ptfe gasket

Press. max.: 500 Bar / 7250 Psi  
**FM2004 - 100 Mesh filter included**



CODE	DESCRIPTION
FM63056	Swivel spray gun connection fitting F 1/4" BSP x M 1/4" BSP
FM63058	Swivel spray gun connection fitting F 1/4" NPS x M 1/4" NPS
FM63057	Swivel spray gun connection fitting F 3/8" BSP x M 3/8" BSP
FM63059	Swivel spray gun connection fitting F 3/8" NPS x M 3/8" NPS

Press. max.: 500 Bar / 7250 Psi



CODE	DESCRIPTION
FM63001	Straigh filter holder F 1/4" BSP x M 1/4" BSP
FM63002	Straigh filter holder F 1/4" BSP x M 3/8" BSP
FM63003	Straigh filter holder F 3/8" BSP x M 3/8" BSP
FM63030	Straigh filter holder F 1/4" BSP x M 16x1,5mm
FM63031	Straigh filter holder F 3/8" BSP x M 1/4" BSP
FM63036	Straigh filter holder F 1/2" JIC x M 1/2" JIC
FM63037	Straigh filter holder F 1/2" JIC x M 1/4" BSP
FM63038	Straigh filter holder F 1/2" JIC x M 3/8" BSP
301500	Spring for filter holder
302002R	Ptfe gasket

Press. max.: 500 Bar / 7250 Psi  
**FM2004 - 100 Mesh filter included**



CODE	DESCRIPTION
FM66001C	S. steel bended filter holder F 1/4" BSP x M 1/4" BSP
FM66002C	S. steel bended filter holder F 1/4" BSP x M 3/8" BSP
FM66003C	S. steel bended filter holder F 3/8" BSP x M 3/8" BSP
FM66030C	S. steel bended filter holder F 1/4" BSP x M 16x1,5mm
FM66031C	S. steel bended filter holder F 3/8" BSP x M 1/4" BSP
301500	Spring for filter holder
302002R	Ptfe gasket

Press. max.: 500 Bar / 7250 Psi  
**FM2004 - 100 Mesh filter included**



## INLINE FILTERS



*Berizzi produces and supplies inline filters for pumps and spraying systems compatible with the products of the main brands available on the market.*

*Berizzi inline filters are manufactured with special materials, extremely hard and compact, processed with high precision technologies in order to guarantee exceptional quality and maximum durability.*

# INLINE FILTERS

For quantities it is possible to change on request the fittings sizes of products below

K470



CODE	DESCRIPTION
FM62002	K470 Steel/aluminium inline filter COMPLETE OF FITTINGS, FILTER SUPPORT AND 60 MESH FILTER
300001R	Steel lower base
300002R	Ptfe gasket
300003R	Aluminium support/core for strainer
300004R	Stainless steel spring
300005R	Aluminium upper cylinder
300006R	Nylon support/core for strainer
49505	Plug 1/4"
163838R	Adapter M 3/8"(BSP) reduced x F 3/8"(BSP) swivel nut
151414	Nipple F 1/4" x F 1/4"
FM22XX	Inline filter sieve Ø26,5 H144mm

Filters FM2200 - FM2212 (see page 84)

Pres. max.: 250 Bar (Psi 3625)  
Material inlet fitting size: F 3/8"  
Material outlet fitting size: M 1/4"

COMPATIBLE with GRACO

K570



CODE	DESCRIPTION
FM62001	K570 Stainless steel inline filter COMPLETE OF FITTINGS, FILTER SUPPORT AND 60 MESH FILTER
301001R	Stainless steel lower base
300002R	Ptfe gasket
300006R	Nylon support/core for strainer
300004R	Stainless steel spring
301005R	Stainless steel upper cylinder
301006R	Stainless steel plug 1/4"
163838IR	Adapter SS M 3/8"(BSP) Reduced x F 3/8"(BSP) swivel nut
151414I	Nipple in stainless steel 1/4"
FM22XX	Inline filter sieve Ø26,5 H144mm

Filters FM2200 - FM2212 (see page 84)

Pres. max.: 500 Bar (Psi 7250)  
Material inlet fitting size: F 3/8"  
Material outlet fitting size: M 1/4"

COMPATIBLE with GRACO

K370



CODE	DESCRIPTION
FM62003	K370 Nylon inline filter COMPLETE OF FITTINGS, FILTER SUPPORT AND 60 MESH FILTER
303001R	Nylon lower base
303002R	Ptfe gasket
300006R	Nylon support/core for strainer
300004R	Stainless steel spring
303005R	Nylon upper cylinder
49505	Plug 1/4"
163838R	Adapter M 3/8" (BSP) reduced x F 3/8" (BSP) swivel nut
151414	Nipple F 1/4" x F 1/4"
FM22XX	Inline filter sieve Ø26,5 H144mm

Filters FM2200 - FM2212 (see page 84)

Pres. max.: 60 Bar (Psi 870)  
Material inlet fitting size: F 3/8"  
Material outlet fitting size: M 1/4"

COMPATIBLE with GRACO

K75I - K75A



CODE	DESCRIPTION
FM62009	K75I Stainless steel inline filter COMPLETE OF FITTINGS, FILTER SUPPORT AND 60 MESH FILTER
300005I	Stainless steel upper cylinder
300004R	Stainless steel spring
FM620020	Aluminium support/core for strainer
300002R	Ptfe gasket
301001R	Stainless steel lower base
301006R	Plug 1/4" in stainless steel
163838IR	Adapter SS M 3/8"(BSP) Reduced x F 3/8" (BSP) swivel nut
151414I	Nipple stainless steel 1/4"
FM23XX	Inline filter sieve Ø26,5 H75mm
FM62010	K75A Aluminium inline filter COMPLETE OF FITTINGS, FILTER SUPPORT AND 60 MESH FILTER
300005P	Aluminium upper cylinder
300001R	Steel lower base
300004R	Stainless steel spring
FM620020	Aluminium support/core for strainer
303002R	Ptfe gasket
49505	Plug 1/4"
163838R	Adapter M 3/8"(BSP) reduced x F 3/8" (BSP) swivel nut
151414	Nipple F 1/4" x F 1/4"
FM23XX	Inline filter sieve Ø26,5 H75mm

Filters FM2301 - FM2305 (see page 85)

Pres. max.: 500 Bar (Psi 7250)  
Material inlet fitting size: F 3/8"  
Material outlet fitting size: M 1/4"

COMPATIBLE with GRACO

# INLINE FILTERS

For quantities it is possible to change on request the fittings sizes of products below



K970

COMPATIBLE with KREMLIN

CODE	DESCRIPTION
FM62011	K970 stainless steel inline filter COMPLETE OF FITTINGS, FILTER SUPPORT AND 60 MESH FILTER
BBS1066	Stainless steel upper cylinder
BBS1063	Stainless steel lower base
FM3400	S.steel spring Ø 21H122mm type Kremlin, Böllhoff
301006R	Plug 1/4" in stainless steel
163838IR	Adapter SS M 3/8"(BSP) Reduced x F 3/8"(BSP) swivel nut
151414I	Nipple in stainless steel 1/4"
FM24XX	Inline filter sieve Ø27 H115mm

Filters FM2401 - FM2412 (see page 86)

Pres. max.: 500 Bar (Psi 7250)  
Material inlet fitting size: F 3/8"  
Material outlet fitting size: M 1/4"



K670

COMPATIBLE with BINKS - WIWA

CODE	DESCRIPTION
FM62004	K670 Stainless steel inline filter COMPLETE OF FITTINGS, FILTER SUPPORT AND 60 MESH FILTER
670001	Nipple for hose 6x8
023050	HP Valve in stainless steel 1/4" FF
151414I	Nipple in stainless steel 1/4"
301006R	Plug 1/4"
163814I	Adaptor 3/8" x 1/4" in stainless steel
670002	Stainless steel lower base
FM31XX	Filter type III
670003	Ptfe gasket
670004	Stainless steel upper cylinder

Filters FM3101 - FM3104 (see page 87)

Pres. max.: 280 Bar (Psi 4060)  
Material inlet fitting size: F 3/8"  
Material outlet fitting size: M 1/4"



K870

COMPATIBLE with BINKS - WIWA

CODE	DESCRIPTION
FM62007	K870 Stainless steel inline filter COMPLETE OF FITTINGS, FILTER SUPPORT AND 60 MESH FILTER
870001	Alluminium gasket
870002	Stainless steel lower base
870003	Ptfe gasket
870004	Threaded rod
870006	Stainless steel upper cylinder
FM26XX	Filter type Wiwa

Filters FM2600 - FM2606 (see page 87)

Pres. max.: 500 Bar (Psi 7250)  
Material inlet fitting size: F 22x1,5mm  
Material outlet fitting size: M 3/8"



K770

COMPATIBLE with BINKS

CODE	DESCRIPTION
FM62006	K770 anodized aluminium inline fluid filter COMPLETE OF FITTINGS, FILTER SUPPORT AND 60 MESH FILTER
300001T	Aluminium lower base
300002T	Ptfe gasket
300006T	Stainless steel screw 6mm for seatl
300004T	Nut in stainless steel for strainer
300003T	Aluminium support/core for strainer
300007T	Stainless steel screw 5mm for top strainer
300005T	Aluminium upper cylinder
49505	Plug 1/4"
163838R	Adapter M 3/8"(BSP) reduced x F 3/8"(BSP) swivel nut
151414	Nipple F 1/4" x F 1/4"
FM22XX	Inline strainer (FM2201B-FM2205B)

Filters FM2201B - FM2205B (see page 84)

Pres. max.: 280 Bar (Psi 4060)  
Material inlet fitting size: F 1/4"  
Material outlet fitting size: M 1/4"

## GRAVITY TANKS



*Berizzi produces and supplies gravity tanks for paint spraying pumps, low pressure spray guns and spraying systems compatible with the products of the main brands available on the market.*

*Berizzi gravity tanks are made of plastic or stainless steel, in different sizes and with different flow rates.*

# GRAVITY TANKS



CODE	DESCRIPTION
FM61350	35L gravity tank with cover
FM61350C	Cover for 35L gravity tank
FM61340	Reducer M 2" F36x2mm + filter + gasket
FM61350G	PTFE gasket for reducer
FM3014S	Stainless steel disc filter ø51mm 20 Mesh

## STEEL CONNECTION



CODE	DESCRIPTION
FM61000	White gravity tank 6L F36x2mm with cover
FM61000B	Black gravity tank 6L F36x2mm with cover
FM61000BCO	Black conductive gravity tank 6L F36x2mm
FM61000C	White cover for FM61000
FM61000CB	Black cover for FM61000B
FM61000CBC	Black conductive cover for FM61000BCO
FM61001	Spring ø87,5mm for 6L gravity tank
FM3013	Disc filter for 6L gravity tank stainless steel/Nylon

## STAINLESS STEEL CONNECTION



CODE	DESCRIPTION
521000	20L stainless steel gravity tank F36x2mm with cover and spring
521000C	Stainless steel cover
FM3406	Spring ø87mm for 20L gravity tank

CODE	DESCRIPTION
FM61002	"L" adapter M 36x2" x FG 1/2"
FM61052	"L" adapter M 36x2" x FG 1/2" SHORT
FM61004	"L" adapter M 36x2" x FG 36x2"
FM61003	"L" adapter M 36x2" x FG 3/4"
FM61013	"L" adapter M 36x2" x FG 36x2" SHORT
FM61090	"L" adapter M 36x2" x FG 26x125
FM61014	"L" adapter M 36x2" x FG 1"
400088C	Green conical gasket

## STAINLESS STEEL CONNECTION AND PIPE



CODE	DESCRIPTION
FM610021	"U" adapter M 36x2mm x FG 1/2"
FM610031	"U" adapter M 36x2mm x FG 3/4"
FM610041	"U" adapter M 36x2mm x FG 36x2mm
FM610051	"U" adapter M 36x2mm x FG 26x125
FM610141	"U" adapter M 36x2mm x FG 1"
400088C	Green conical gasket

## STAINLESS STEEL CONNECTION AND PIPE



CODE	DESCRIPTION
FM610061	"U" oblique adapter M36x2mm x FG 3/4"
FM610062	"U" oblique adapter M36x2mm x FG 36x2mm
FM610063	"U" oblique adapter M36x2mm x FG 26x125
FM610064	"U" oblique adapter M36x2mm x FG 1/2"
400088C	Green conical gasket

## STAINLESS STEEL CONNECTION AND PIPE



CODE	DESCRIPTION
FM61008	Brass reducer F3/4" x M 36x2mm
FM61007	Brass reducer F1" x M 36x2mm
FM61088	Stainless steel reducer F22x3 x M 36x2mm
FM61089	Stainless steel reducer M1" x F 36x2mm

CODE	DESCRIPTION
FM61005	Nipple MM 1" x 36x2mm
FM61006	Nipple MM 3/4" x 36x2mm
FM61066	Nipple MM 1/2" x 36x2mm
FM61005S	Stainless steel nipple MM 1" x 36x2mm
FM61006S	Stainless steel nipple 3/4" x 36x2mm
FM61066S	Stainless steel nipple 1/2" x 36x2mm

# GRAVITY TANKS



CODE	DESCRIPTION
SER60011	Nylon 600cc cup M 1/4" BSP stainless steel compatible with <b>Kremlin</b>
SER60012	Nylon 600cc cup M 12X1 brass
SER60013	Nylon 600cc cup M 13x1 brass
SER60014	Nylon 600cc cup M 14x1,25 brass
SER60015	Nylon 600cc cup M 12x1,5 brass
SER60016	Nylon 600cc cup F 16x1,5 stainless steel compatible with <b>Anest-Iwata</b>
BBS40SE	Nylon 600cc cup M 16x1,5 stainless steel
SER60017	Nylon 600cc cup M 3/8" BSP stainless steel compatible with <b>DeVilbiss 501</b>
SER60018	Nylon 600cc cup F 3/8" stainless steel compatible with <b>Optima</b>

\*For the model compatibility of our tanks with those of other brands on the market, check the table on the opposite page



CODE	DESCRIPTION
SER60011B	Black nylon 600cc cup M 1/4" BSP stainless steel compatible with <b>Kremlin</b>
SER60012B	Black nylon 600cc cup M 12x1 brass
SER60013B	Black nylon 600cc cup M 13x1 brass
SER60014B	Black nylon 600cc cup M 14x1,25 brass
SER60015B	Black nylon 600cc cup M 12x1,5 brass
SER60016B	Black nylon 600cc cup F 16x1,5 stainless steel compatible with <b>Anest-Iwata</b>
SER60017B	Black nylon 600cc cup M 3/8" BSP stainless steel compatible with <b>DeVilbiss 501</b>
SER60018B	Black nylon 600cc cup F 3/8" stainless steel compatible with <b>Optima</b>

Berizzi black gravity tanks are perfect for UV paints. Thanks to their construction, they block any passage of light, guaranteeing the technical stability of the sprayed material

For the model compatibility of our tanks with those of other brands on the market, please check the following table:

BRAND	MODEL	CODE																		
		SER60011	SER60012	SER60013	SER60014	SER60015	SER60016	SER60017	SER60018	SER60019	SER60020	SER60021	SER60022	SER60023	SER60024	SER60025	SER60026	SER60027	SER60028	
ANI	ANI 200 - AT/LUX - F150 - ANI150																			
	F1 CAR-F1, S-F1 PLUS, AT LUX/S																			
ANEST IWATA	F1-F1 SUPER, AT, RV																			
	W 400 - W 400WB - WR 400 - LPA 94																			
DEVILBISS	VXL 949 Primer Gun - LPH 400 HVLP																			
	WS400 Pinifarina, SuperNova																			
GRACO	GTI, GFR, GFV, GFHV 510, GFG, GFG Pro, GTI Pro, GTI Pro Lite, Pri Pro																			
	Delta Spray HVLP, Airpro, Finex																			
KREMLIN	Hti-G, M21G, M22, M22G, F Pro G																			
	403, 424, 433, 475, 434G, 444G, 450G																			
SAGOLA	3200G EPA, 3300G, 4100G, 4200G																			
	EPA, 4300 Xtreme																			
SATA	Model 71-75																			
	Jet B NR 95 HVLP, NR 92 HVLP																			
WALCOM	B/NR-92/NR-95																			
	Jet RP-RP Digital, Jet 90/S, KLC, KLCB																			
WALTHER PILOT	KLC, KLC-RP, LM2000, LM92, MCB																			
	MCB90, 90/90-2HVLP NR 2000/RP																			
GENESI	NR 2000 Digital																			
	MC 93, MCB-93																			
PILLOT IV, PILOT MAXI, PILOT MINI HD	Geo FX 97, Slim S, Slim S HVLP																			
	FX HA, FX HVLP, FX GEO, STV-HVLP																			
878, 827-C																				



## SPRAY GUNS SPARE PARTS

*Berizzi produces and supplies spare parts for professional paint spraying guns, both manual and automatic, compatible with the products of the main brands available on the market: Kremlin, Graco, Optima and Wagner.*



COMPATIBLE with KREMLIN page 142  
COMPATIBLE with GRACO page 157  
COMPATIBLE with OPTIMA page 159  
COMPATIBLE with WAGNER page 162



# SPRAY GUNS SPARE PARTS

COMPATIBLE with KREMLIN



CODE	DESCRIPTION	OEM REF.
KN1001	Air cap type VX 14	132.670.920

Compatible with guns type: MVX - AXC - AVX - XCITE



CODE	DESCRIPTION	OEM REF.
KN1002	Air cap type BX 16	132.620.026 132.650.450

Compatible with guns type: ATX



CODE	DESCRIPTION	OEM REF.
KN1003	Air cap type VX 54	132.670.030

Compatible with guns type: MVX - AXC - AVX



CODE	DESCRIPTION	OEM REF.
KN1004	Air cap type BX 116	132.650.500 132.650.550

Compatible with guns type: ATX



CODE	DESCRIPTION	OEM REF.
KN1005	Air cap type VX 114	132.670.940

Compatible with guns type: AXC - AVX

COMPATIBLE with KREMLIN



CODE	DESCRIPTION	OEM REF.
KN1070	Air cap type VX 24	132.720.020

Compatible with guns type: AVX - AXC - MVX - XCITE



CODE	DESCRIPTION	OEM REF.
KN1071	Air cap type VX 124	132.720.055

Compatible with guns type: AVX - XCITE - AXC - MVX



CODE	DESCRIPTION	OEM REF.
KN1025	Air cap ring	032.020.001

Compatible with guns type: ATX



PACKS OF 10 PCS

CODE	DESCRIPTION	OEM REF.
KN1047	Seal for air cap	150.040.309

Compatible with guns type: ATX



CODE	DESCRIPTION	OEM REF.
KN1042	Air cap ring	029.670.006

Compatible with guns type: AVX - MVX - AXC - MACH3

# SPRAY GUNS SPARE PARTS

COMPATIBLE with KREMLIN



CODE	DESCRIPTION
KN1072	Air cap ring

Compatible with guns type: XCITE



CODE	DESCRIPTION	OEM REF.
KN1043	Spring for air cap	032.670.003

Compatible with guns type: MVX - AVX - AXC



PACKS OF 2 PCS

CODE	DESCRIPTION	OEM REF.
KN1020	Seal for air cap	129.670.075

Compatible with guns type: MVX - AVX - AXC



PACKS OF 10 PCS

CODE	DESCRIPTION	OEM REF.
KN1019	Seal for air cap	150.040.330

Compatible with guns type: MVX - AXC - AVX - XCITE



CODE	DESCRIPTION	OEM REF.
KN1021	Seat holder without seat	129.679.907

Compatible with guns type: AVX - MVX - AXC

COMPATIBLE with KREMLIN



PACKS OF 10 PCS

CODE	DESCRIPTION	OEM REF.
KN1012	O-ring	150.040.329

Compatible with guns type: ATX - MVX - AXC - AVX - XCITE



CODE	DESCRIPTION	OEM REF.
KN1065	Diffuser kit	129.729.907

Compatible with guns type: XCITE



PACKS OF 5 PCS

CODE	DESCRIPTION	OEM REF.
KN1066	Front seal for diffuser	129.729.912

Compatible with guns type: XCITE



PACKS OF 10 PCS

CODE	DESCRIPTION	OEM REF.
KN1067	Rear seal for diffuser	129.729.913

Compatible with guns type: XCITE



CODE	DESCRIPTION	OEM REF.
KN1068	Complete kit for diffuser	129.626.400

Compatible with guns type: ATX

# SPRAY GUNS SPARE PARTS

COMPATIBLE with KREMLIN

COMPATIBLE with KREMLIN



PACKS OF 10 PCS

CODE	DESCRIPTION	OEM REF.
KN1053	Seal	129.609.902

Compatible with guns type: ATX

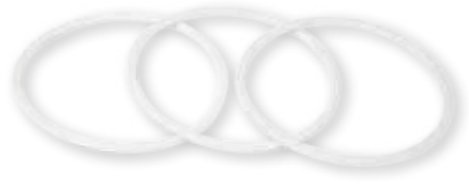

PACKS OF 10 PCS

CODE	DESCRIPTION	OEM REF.
KN1069	Rear seal for diffuser	129.629.914

Compatible with guns type: ATX



CODE	DESCRIPTION	OEM REF.
KN1023	Screw	029.600.106

Compatible with guns type: AVX - ATX - AXC - MVX - XCITE



PACKS OF 10 PCS

CODE	DESCRIPTION	OEM REF.
KN1035	Seat acetal resin	126.729.904

Compatible with guns type: XCITE



PACKS OF 10 PCS

CODE	DESCRIPTION	OEM REF.
KN1034	Seat acetal resin	129.609.911

Compatible with guns type: ATX



PACKS OF 2 PCS

CODE	DESCRIPTION	OEM REF.
KN1039	Stainless steel seat + seal	129.679.905

Compatible with guns type: AVX - MVX - AXC



PACKS OF 2 PCS

CODE	DESCRIPTION	OEM REF.
KN1040	Stainless steel seat + seal	129.629.923

Compatible with guns type: ATX



PACKS OF 2 PCS

CODE	DESCRIPTION	OEM REF.
KN1041	Stainless steel seat + seal	129.729.905

Compatible with guns type: XCITE



PACKS OF 10 PCS

CODE	DESCRIPTION
KN1055	Delrin seal for stainless steel seat

Compatible with guns type: XCITE



PACKS OF 10 PCS

CODE	DESCRIPTION	OEM REF.
KN1010	Seal seat	129.629.922

Compatible with guns type: XCITE - AXC - ATX - MVX - AVX

# SPRAY GUNS SPARE PARTS

COMPATIBLE with KREMLIN



CODE	DESCRIPTION	OEM REF.
KN1081	Needle cartridge type KN MVX	129.679.903

Compatible with guns type: MVX



PACKS OF 10 PCS

CODE	DESCRIPTION	OEM REF.
KN1082	PTFE seal	150.040.315



PACKS OF 10 PCS

CODE	DESCRIPTION	OEM REF.
KN1083	Seal type for cartridge	144.585.354



CODE	DESCRIPTION	OEM REF.
KN1084	Piston coupling	144.850.157



CODE	DESCRIPTION	OEM REF.
KN1085	Cartridge type GT	144.030.157

COMPATIBLE with KREMLIN



CODE	DESCRIPTION	OEM REF.
KN1059	Complete needle kit 120 Bar	129.720.150

Compatible with guns type: XCITE



CODE	DESCRIPTION	OEM REF.
KN1060	Complete needle kit 200 Bar	129.720.250

Compatible with guns type: XCITE



PACKS OF 10 PCS

CODE	DESCRIPTION	OEM REF.
KN1061	Cartridge gasket needle	109.420.298

Compatible with guns type: XCITE



PACKS OF 5 PCS

CODE	DESCRIPTION	OEM REF.
KN1063	Spring for needle kit 120 Bar	129.729.914

Compatible with guns type: XCITE

PACKS OF 5 PCS



PACKS OF 10 PCS

CODE	DESCRIPTION	OEM REF.
KN1064	Spring for needle kit 200 Bar	129.729.915

Compatible with guns type: XCITE

CODE	DESCRIPTION	OEM REF.
KN1062	Seeger for needle kit	102.202.113

Compatible with guns type: XCITE

# SPRAY GUNS SPARE PARTS

COMPATIBLE with KREMLIN



CODE	DESCRIPTION	OEM REF.
KN1009	Complete needle	129.626.100

Compatible with guns type: ATX



PACKS OF 10 PCS

CODE	DESCRIPTION	OEM REF.
KN1018	Seal	129.529.906

Compatible with guns type: ATX



PACKS OF 4 PCS

CODE	DESCRIPTION	OEM REF.
KN1011	Complete needle	129.690.050

Compatible with guns type: AVX - AXC



CODE	DESCRIPTION	OEM REF.
KN1022	Cartridge with seal	129.690.039

Compatible with guns type: AVX - AXC - A35HTI - A35HPA



CODE	DESCRIPTION	OEM REF.
KN1013	White seal, polyfluid seat	909.429.702

Compatible with guns type: AVX - AXC

COMPATIBLE with KREMLIN



PACKS OF 10 PCS

CODE	DESCRIPTION	OEM REF.
KN1024	Needle cartridge	029.626.200

Compatible with guns type: ATX - AVX - AXC

CODE	DESCRIPTION	OEM REF.
KN1054	Seal for needle cartridge (10 pcs)	129.400.915

Compatible with guns type: ATX - AVX - AXC



CODE	DESCRIPTION	OEM REF.
KN1045	Special nut	029.251.303

Compatible with guns type: ATX - AVX - AXC



CODE	DESCRIPTION	OEM REF.
KN1044	Fluid leakage detector	029.690.001

Compatible with guns type: AVX - AXC



PACKS OF 10 PCS

CODE	DESCRIPTION	OEM REF.
KN1048	R8 seal	129.251.992

Compatible with guns type: ATX



PACKS OF 10 PCS

CODE	DESCRIPTION	OEM REF.
KN1049	R22 seal	129.251.993

Compatible with guns type: ATX

# SPRAY GUNS SPARE PARTS

COMPATIBLE with KREMLIN

COMPATIBLE with KREMLIN



PACKS OF 10 PCS

CODE	DESCRIPTION	OEM REF.
KN1046	Seal	150.040.328

Compatible with guns type: AVX



PACKS OF 10 PCS

CODE	DESCRIPTION	OEM REF.
KN1006	PTFE seal	129.251.991

Compatible with guns type: ATX - AVX



PACKS OF 10 PCS

CODE	DESCRIPTION	OEM REF.
KN1017	PTFE seal	129.525.092

Compatible with guns type: ATX



PACKS OF 5 PCS

ONLY SCREEN

CODE	DESCRIPTION	OEM REF.
FM2814	Only s.s. support for screen nr. 4/6/12	029.520.310

CODE	DESCRIPTION	OEM REF.
KN1008	Filter nr. 6 (Ø 9,5H 17,5mm) 168µ (5pcs)	129.609.908
KN1014	Filter nr. 4 (Ø 9,5H 17,5mm) 99µ (5pcs)	129.609.907
KN1015	Filter nr. 12 (Ø 9,5H 17,5mm) 280µ (5pcs)	129.609.909

Compatible with guns type: MXLT - MVX



PACKS OF 2 PCS

PACKS OF 5 PCS

CODE	DESCRIPTION	OEM REF.
KN1026	Filter Nr. 2 + delrin support	129.629.906
KN1027	Filtro Nr. 4 + delrin support	129.629.905
KN1028	Filtro Nr. 6 + delrin support	129.629.907
KN1029	Filtro Nr. 8 + delrin support	129.629.916

CODE	DESCRIPTION	OEM REF.
KN1030	Filter Nr. 2 (Ø 9,5 H 11mm) 77µ 200 Mesh	029.620.015
KN1031	Filter Nr. 4 (Ø 9,5 H 11mm) 99µ 140 Mesh	029.620.008
KN1032	Filter Nr. 6 (Ø 9,5 H 11mm) 168µ 85 Mesh	029.620.016
KN1033	Filter Nr. 8 (Ø 9,5 H 11mm) 210µ 75 Mesh	029.620.022
FM2816	Delrin support for filters nr. 2/4/6/8 (1pc)	029.620.003

Compatible with guns type: ATX

CODE	DESCRIPTION
KKN4XX	Nozzle type Kremlin
KKN2XX	Nozzle type Kremlin with pre-orifice
KN001	Gasket

Compatible with guns type: ATX - AVX - MVX - AXC - XCITE



PACKS OF 10 PCS

CODE	DESCRIPTION	OEM REF.
KN1016	Microfilter 99µ	129.609.901

Compatible with guns type: AVX - ATX - MVX - XCI - AXC



PACKS OF 10 PCS

CODE	DESCRIPTION	OEM REF.
KN1007	Gasket for nozzle 09	129.529.903

Compatible with guns type: ATX - AVX - AXC - MVX - XCITE

# SPRAY GUNS SPARE PARTS

COMPATIBLE with KREMLIN



CODE	DESCRIPTION	OEM REF.
KN1074	Colour change valve - low pressure	155535110
KN1077	Cartridge kit	155535140

Spare parts available, see the table below

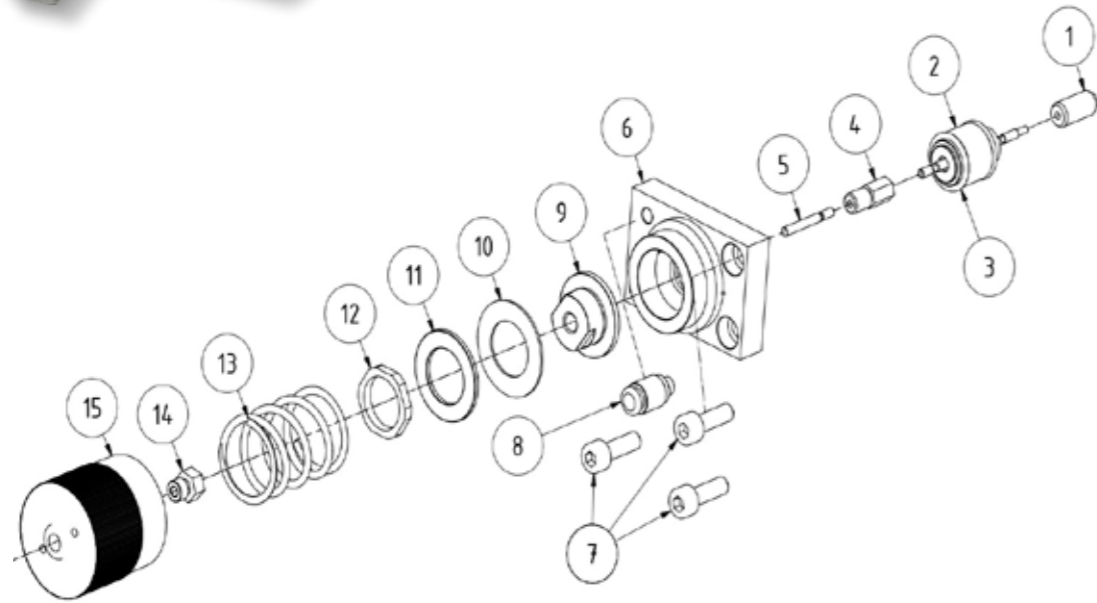

POS	CODE	OEM REF	DESCRIPTION
1-15	KN1074	155535110	Complete change color valve
1	KN1073D	155501004	Closing needle joint
2	KN1077	155535140	Complete cartridge
3	KN1078	129529918	Kit gaskets x10 pcs
4	KN1073B	055501003	Rod carrier
5	KN1073R	055501008	Rod controll
6	KN1073E	055535121	Support base
7	VTCEXUS	933151221	Screw
8	110405	905120944	Quick connector
9	KN1073O	029875301	Piston only
10	KN1073N	029711302	Piston gasket
11	KN1073M	029711303	Piston washer
12	KN1073L	029711304	Closing piston nut
13	KN1073Q	050313504	Spring
14	KN1073I	055501009	Carrier rod controll
15	KN1073H	029711401	Closing plug valve

COMPATIBLE with KREMLIN



CODE	DESCRIPTION	OEM REF.
KN1075	Colour change valve - medium pressure	155535310
KN1077	Cartridge kit	155535140

Spare parts available, see the table below

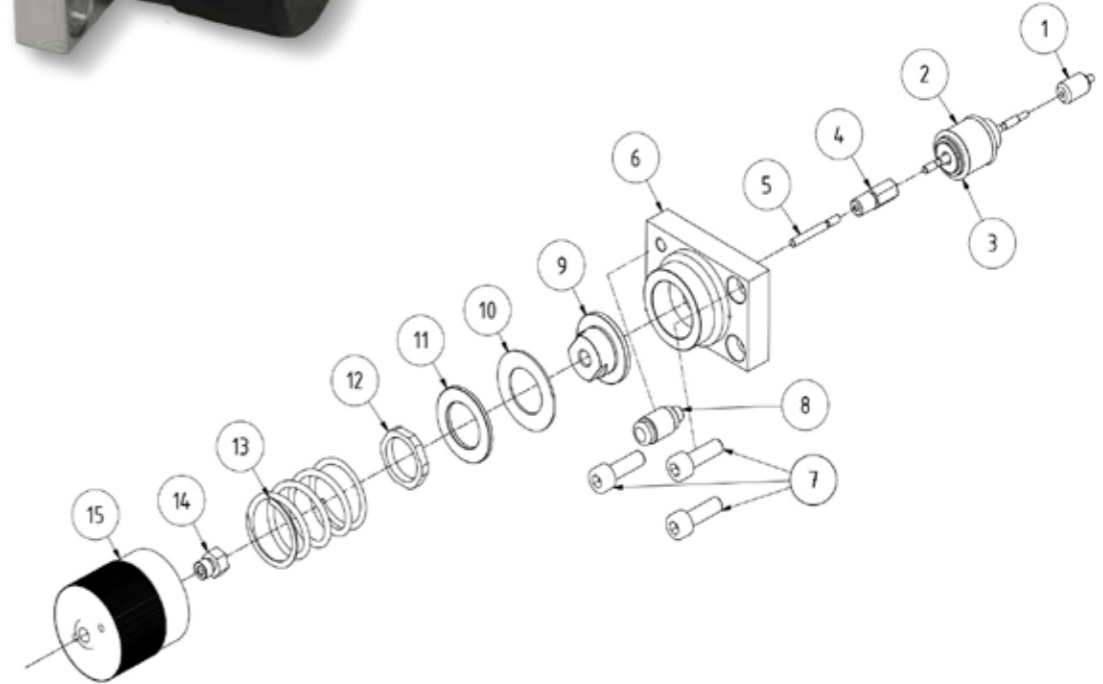

POS	CODE	OEM REF	DESCRIPTION
1-15	KN1075	155535310	Complete change color valve
1	KN1073P	155507013	Closing needle joint
2	KN1077	155535140	Complete cartridge
3	KN1078	129529918	Kit gaskets x10 pcs
4	KN1073B	055501003	Rod carrier
5	KN1073R	055501008	Rod controll
6	KN1073E	055535121	Support base
7	VTCEXUS	933151221	Screw
8	110405	905120944	Quick connector
9	KN1073O	029875301	Piston only
10	KN1073N	029711302	Piston gasket
11	KN1073M	029711303	Piston washer
12	KN1073L	029711304	Closing piston nut
13	KN1073Q	050313504	Spring
14	KN1073I	055501009	Carrier rod controll
15	KN1073H	029711401	Closing plug valve

# SPRAY GUNS SPARE PARTS

COMPATIBLE with KREMLIN

COMPATIBLE with GRACO



CODE	DESCRIPTION	OEM REF.
KN1076	Colour change valve - high pressure	155535315
KN1080	Cartridge kit	155528012

Spare parts available, see the table below

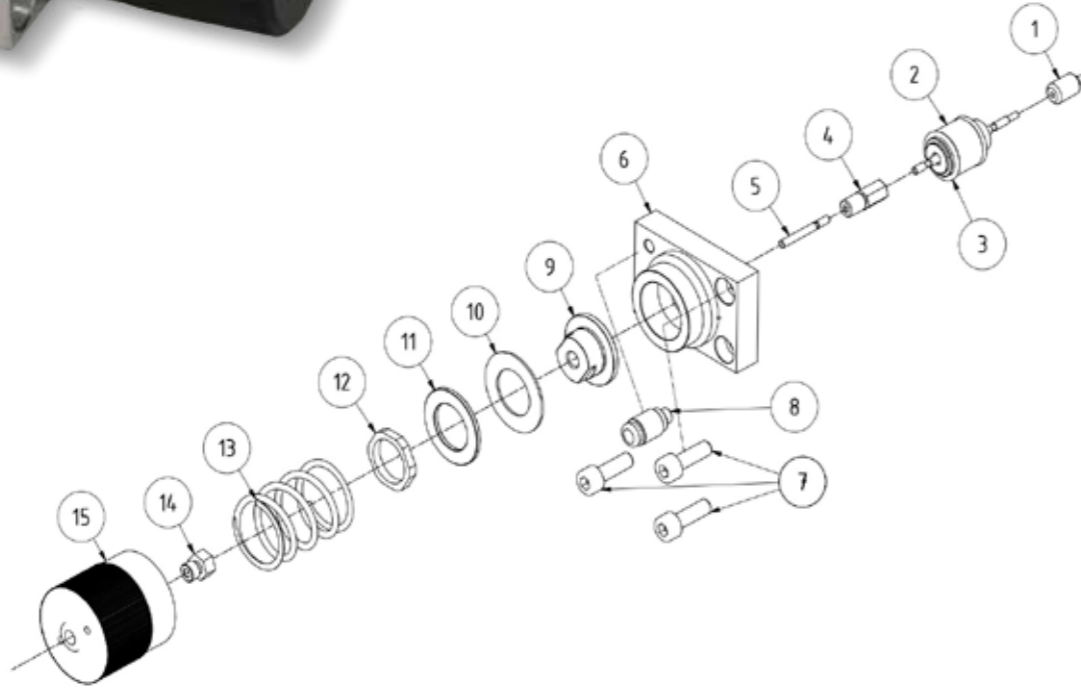

POS	CODE	OEM REF	DESCRIPTION
1-15	KN1076	155535110	Complete change color valve
1	KN1073P	155507013	Closing needle joint
2	KN1080	155528012	Complete cartridge
3	KN1078	129529918	Kit gaskets x10 pcs
4	KN1073B	055501003	Rod carrier
5	KN1073A	055501010	Rod control
6	KN1073E	055535121	Support base
7	VTCEXUS	933151221	Screw
8	110405	905120944	Quick connector
9	KN1073O	029875301	Piston only
10	KN1073N	029711302	Piston gasket
11	KN1073M	029711303	Piston washer
12	KN1073L	029711304	Closing piston nut
13	KN1073F	050316501	Spring
14	KN1073I	055501009	Carrier rod control
15	KN1073T	055535316	Closing plug valve



CODE	DESCRIPTION	OEM REF.
GC1001	Air cap	249180

Compatible with guns type: G40



CODE	DESCRIPTION
GWNXXX	Nozzle mix type Graco
GWN2XXX	Nozzle mix type Graco with pre-orifice
GN001	Gasket



CODE	DESCRIPTION	OEM REF.
GC1002	Spray gun needle	24B789

Compatible with guns type: G15 - G40



CODE	DESCRIPTION	OEM REF.
GC1003	PTFE gasket	110004

Compatible with guns type: G15 - G40 - G40 AUTO



CODE	DESCRIPTION	OEM REF.
GC1004	Complete diffuser	249133

Compatible with guns type: G15 - G40



# SPRAY GUNS SPARE PARTS

## COMPATIBLE with GRACO

## COMPATIBLE with OPTIMA



CODE	DESCRIPTION	OEM REF.
GC1005	Front gasket diffuser	111116

Compatible with guns type: G15 - G40



CODE	DESCRIPTION	OEM REF.
GC1006	Middle gasket diffuser	109450

Compatible with guns type: G15 - G40



CODE	DESCRIPTION	OEM REF.
GC1007	Rear gasket diffuser	111457

Compatible with guns type: G15 - G40



CODE	DESCRIPTION	OEM REF.
GC1008	Spray gun needle	288191

Compatible with guns type: G40 AUTO



CODE	DESCRIPTION	OEM REF.
GC1009	Spray gun needle kit	235474

Compatible with guns type: Silver - Flex



CODE	DESCRIPTION	OEM REF.
ONXXXX	Nozzle type Optima 2000	001240-U10
102003	Nozzle gasket type Optima 2000	

Compatible with the gun Optima 2000



CODE	DESCRIPTION	OEM REF.
OPNXXX	Nozzle type Optima 2100	001248-U8
ON001N	Nozzle gasket type Optima 2100	

Compatible with the gun Optima 2100



CODE	DESCRIPTION	OEM REF.
102002	Air cap type Optima 2000	001240-U2

Compatible with the gun Optima 2000



CODE	DESCRIPTION	OEM REF.
102102	Air cap type Optima 2100	001248-U2

Compatible with the gun Optima 2100



CODE	DESCRIPTION	OEM REF.
102001	Lock nut type Optima 2000	001240-6

Compatible with the gun Optima 2000

# SPRAY GUNS SPARE PARTS

## COMPATIBLE with OPTIMA



CODE	DESCRIPTION	OEM REF.
102101	Lock nut type 2100	001240-U10

Compatible with the gun Optima 2100



CODE	DESCRIPTION	OEM REF.
102004	PTFE gasket for air cap	001233-9

Compatible with guns: Optima 2000 and Optima 2100



CODE	DESCRIPTION	OEM REF.
102031	Gaskets	001233-8

Compatibile con la pistola Optima 2000



CODE	DESCRIPTION	OEM REF.
102003	Seal for nozzle	001196-24

Compatible with guns: Optima 2000 and Optima 2100



CODE	DESCRIPTION	OEM REF.
102005	Screw	001240-U4

Compatible with guns: Optima 2000 and Optima 2100

## COMPATIBLE with OPTIMA



CODE	DESCRIPTION	OEM REF.
102006	Seal ring	001240-25

Compatible with the gun Optima 2000



CODE	DESCRIPTION	OEM REF.
102007	Gasket 3,5x1mm Viton	00104-0018

Compatible with guns: Optima 2000 and Optima 2100



CODE	DESCRIPTION	OEM REF.
102008	Gasket 7x1mm Viton	00104-0019

Compatible with guns: Optima 2000 and Optima 2100



CODE	DESCRIPTION	OEM REF.
102020	Gasket 4x1,2mm Viton	00104-0020

Compatible with guns: Optima 2000 and Optima 2100



CODE	DESCRIPTION	OEM REF.
102028	Needle	001230-U4

Compatible with the gun Optima 2000

# SPRAY GUNS SPARE PARTS

COMPATIBLE with WAGNER

COMPATIBLE with WAGNER



CODE	DESCRIPTION	OEM REF.
WA1001	Air cap type HV blue	394911

Compatible with guns: GM 4100AC, GM 4699AC, GM 4600AC-H, GM 4100 and GM 4700AC



CODE	DESCRIPTION	OEM REF.
WA1002	Air cap type LV red	394910

Compatible with guns: GM 4100AC, GM 4699AC, GM 4600AC-H, GM 4100 and GM 4700AC



CODE	DESCRIPTION	OEM REF.
WA1003	Air cap type LV red	364910

Compatible with guns: GM 3000ACIC, GA 3000ACEC and GA 3000ACE



CODE	DESCRIPTION	OEM REF.
WA1004	Air cap type LV blue	394911

Compatible with guns: GM 3000ACIC, GA 3000ACEC and GA 3000ACE



CODE	DESCRIPTION	OEM REF.
WA1005	Lock nut	394308

Complete of gaskets: WA1007 and WA1008.  
Compatible with guns: GM 4100AC, GM 4600AC, GM 4600AC-H, GM 4100 and GM 4700AC



CODE	DESCRIPTION	OEM REF.
WA1006	Lock nut	364302

Compatible with guns: GA 3000ACIC, GA 3000ACEC and GA 3000ACE



CODE	DESCRIPTION
WA1007	Graphite PTFE gasket

CODE	DESCRIPTION
WA1008	PTFE seal

Both compatible with guns: GM 4100AC, GM 4600AC, GM 600AC-H, GM 4100 and GM 4700



CODE	DESCRIPTION	OEM REF.
WA1009	Air cap seal	394339

Compatible with guns: GM 4600AC, GM 4600AC-H, GM 4100 and GM 4700



CODE	DESCRIPTION	OEM REF.
WA1010	Nozzle seal	394338/364328

Compatible with guns: GM 4600AC, GM 4600AC-H, GM 4100AC and GM 3000AC



CODE	DESCRIPTION	OEM REF.
WA1011	Gun needle	394920

Compatible with guns: GM 4600AC, GM 4600AC-H, GM 4700AC-H and GM 4700AC



CODE	DESCRIPTION	OEM REF.
WGMXXXX	Nozzle mix type Wagner	379XXX

Compatible with guns: GM 4100AC, GM 4600AC, GM 4600AC-H, GM 4100 and GM 4700



CODE	DESCRIPTION	OEM REF.
WGM2XXX	Nozzle mix type Wagner with pre-orifice	379XXX

Compatible with guns: GM 4100AC, GM 4600AC, GM 4600AC-H, GM 4100 and GM 4700



## PUMPS SPARE PARTS

*Berizzi produces and supplies spare parts for pumps for professional paint spraying, fluids transfer and extrusion, compatible with the products of the main brands available on the market.*

*Air regulators, membranes, seals, gasket kits, balls, valves, high and low-pressure taps, engine heads and pressure gauges are available.*



DIAPHRAGMS	page 168
PISTON PUMPS KIT GASKETS	page 170
PISTON PUMPS GASKETS	page 172
VALVES COMPATIBLE WAGNER	page 174
VALVES	page 175
HP VALVES	page 177
LP VALVES	page 179
NON RETURN VALVES	page 180
ENGINE HEADS	page 181
VALVE EXCHANGERS	page 181
STROKE COMPENSATORS	page 181
AIR REGULATORS	page 182
MANOMETERS	page 184
WHEELS	page 186
BALLS	page 187

# PUMPS SPARE PARTS

## DIAPHRAGMS



CODE	DESCRIPTION	OEM REF.
BBS1833	Rubber diaphragm for Zip 52 fluid regulator	G726.06
BBS1834	PTFE diaphragm for Zip 52 fluid regulator	G725.05
<b>Ø75 6 HOLES +1</b>		

CODE	DESCRIPTION
BBS1523G	Rubber diaphragm for fluid regulator type Anest Iwata
BBS1523T	PTFE diaphragm for fluid regulator type Anest Iwata
<b>Ø84 6 HOLES +1</b>	

CODE	DESCRIPTION	POS.
040300	Diaphragm K300, Tecover 4000	1
040500	Diaphragm K500, Tecover 5000	
050353	Shim for diaphragm K300, K500, L3000	3
401001	Diaphragm type L3000	4
041000	Diaphragm type K1000, Tecover 10000	5
	Tecover 15000, Giotto, Larius 8000, Sinaer 8000	
050017	Shim for diaphragm K1000, 7000	6

CODE	DESCRIPTION
040110	Diaphragm 8 holes Ø140
040111	Diaphragm 6 holes Ø144 type Larius 2

CODE	DESCRIPTION	Ø	OEM REF.	HOLES
040137T	Diaphragm type Zip Wagner PTFE	115	G921.05	1
040137G	Diaphragm type Zip Wagner rubber	115	G921.06	1
040138	Diaphragm type 1050 Graco rubber + Ptfе	170		1
040224	Diaphragm type B24 rubber + Ptfе	149		1
040120	Diaphragm type Wagner C120 rubber + Ptfе	142		6+1
040120T	Diaphragm type Wagner C120 Ptfе	142		6+1
040121	Diaphragm type BB 121 Ptfе	114		1
040125	Diaphragm type Kremlin PMP150 rubber + Ptfе	149		7+1
040135	Diaphragm type Iwata DDP90 rubber + Ptfе	109		1
040136	Diaphragm type Iwata DDP120 rubber + Ptfе	138		1
040140	Diaphragm type Wagner C500 rubber + Ptfе	210		6+1
040150	Diaphragm type G307 Graco Ptfе	107		1
040144	Monodiaphragm type L4 Larius	206		8+1
040115	Monodiaphragm type Böllhoff	124		0
040116	Diaphragm type V 107 + 115 rubber + Ptfе	125		8+1
040117	Diaphragm type Sinaer 120	150		8+1
040118	Diaphragm type Falcioni rubber + Ptfе	116		1
040119	Diaphragm type B24	149		1



## DIAPHRAGMS



CODE	DESCRIPTION
040120K	Diaphragm and gaskets kit type 120 W-Colora

CODE	DESCRIPTION
040150K	Diaphragm and gaskets kit type 307 Graco

CODE	DESCRIPTION
040135K	Diaphragm and gaskets kit type IW90 Iwata

CODE	DESCRIPTION
040224K	Diaphragm and gaskets kit for B24 pump

CODE	DESCRIPTION
040119K	Diaphragm and gaskets kit for B24 (Nylon) pump

CODE	DESCRIPTION	OEM REF.
040137K	Diaphragm and gaskets kit type Wagner Zip	T.9080.00B

CODE	DESCRIPTION	OEM REF.
040138K	Diaphragm and gaskets kit type Graco 1050	24B627

CODE	DESCRIPTION	OEM REF.
040225K	Diaphragm and gaskets PTFE kit type Triton-Graco	245065

# PUMPS SPARE PARTS

## PISTON PUMPS KIT GASKETS

Gaskets kits for pneumatic piston pumps in different materials: PTFE, leather, high intensity polyethylene or polyurethane, compatible with Binks, Anest Iwata, Graco, Wagner, Asturo, Kremlin, Bettella and Larius



CODE	DESCRIPTION	OEM REF.
WCO121	Gaskets repair kit type C 121	T946.00
WCO181	Gaskets repair kit type C 181	T922.00
WCO201	Gaskets repair kit type C 201	T922.00
WCO251	Gaskets repair kit type C 251	T914.00
WCO281	Gaskets repair kit type C 281	T940.00
WCO371	Gaskets repair kit type C 371	T936.00
WCO401	Gaskets repair kit type C 401	T919.00

COMPATIBLE with WAGNER-COLORA



CODE	DESCRIPTION	OEM REF.
92301K	Repair Kit type L 30 : 1	40055
92451K	Repair Kit type L 45 : 1	40070
92601K	Repair Kit type L 60 : 1	40075
93231K	Repair Kit type OMG/L 23 : 1	40070
93301K	Repair Kit type OMG/L 30 : 1	40075

COMPATIBLE with LARIUS



CODE	DESCRIPTION	OEM REF.
942840K	Repair Kit type W 28-40	0115805-0115806
944890K	Repair Kit type W 48-90	0115909-0115810
943370K	Repair Kit type W 33-70	0115807-0115808
942940K	Repair Kit type W 28-40 Puma	0115805-0367991
941570K	Repair Kit type W15-70/15-150 Puma	0367991-0368991
943570K	Repair Kit type W35-70/35-150 Leopard	0367991-0368991
944015K	Repair Kit type or W EM 40-15	T919.00E
942030K	Repair Kit type W EM 20-30	

COMPATIBLE with WAGNER



CODE	DESCRIPTION
BET030	Self adjusting type Bettella ø30mm
BET038	Self adjusting type Bettella ø38mm
BET050	Self adjusting type Bettella ø50mm
BET032	Self adjusting type AT1 ø32mm
SOF002	Bellow type Bettella

COMPATIBLE with BETTELLA

## PISTON PUMPS KIT GASKETS



CODE	DESCRIPTION	OEM REF.
BB16007	Pump repair kit type MP38/75 ptfe	0114-016007 634660
BB16013	Pump repair kit type MP150/120 ptfe	0114-016013 2548
BB16010	Pump repair kit type MP115/120 ptfe	0114-016010 2066
BB16006	Pump repair kit type MP27/75 ptfe	0114-016006 432
BB16002	Pump repair kit type MP72/75 ptfe	0114-016002 1032
BB16005	Pump repair kit type MP11/42 ptfe	0114-016005 328
BBS1418	Pump repair kit type MX 12/31 ptfe LOW	0115-010264
BBS1415	Pump repair kit type MX 12/31 ptfe UPP	0115-010263

COMPATIBLE with BINKS



CODE	DESCRIPTION	OEM REF.
BBG001	Repair Kit type Ultra 795(1095) MAX3900	244196-248212
BBG002	Repair Kit type Ultra 1595/GMAX5900/MarkV	244198-248213
BBG003	Repair Kit type Ultra 600/395ST/495ST	235-703
BBG004	Repair Kit type Ultramax 695/Ultimate 695	244-194
BBG005	Repair Kit type X/T 45:1	244-853
BBG006	Repair Kit type X/T 56:1	244852-24F967
BBG007	Repair Kit type X/T 68:1	244851-24F969
BBG008	Repair Kit type 56:1	237-163
BBG009	Repair Kit type 45:1	220-395
BBG010	Repair Kit type 63:1	223-658
BBG011	Repair Kit type 68:1	238-117
BBG012	Repair Kit type 30:1 (President)	223-675
BBG013	Repair Kit tipo 23:1 (Monarch)	223-674
BBG014	Repair Kit type Motor King	207-730
BBG015	Repair Kit type Motor President K30	207-385
BBG020	Ptfe Packing Stack 217530/220504	223-482
BBG017	Repair Kit Gmax II 7900 HD - Ceramic - Mark	16X431
BBG025	Repair Kit tipo Merkur 035	233830-245353
BBG030	Repair Kit tipo Merkur 020	233826-245351
BBG035	Repair Kit tipo Merkur 050	233833-245352
BBG040	Repair Kit tipo President	235-635

COMPATIBLE with GRACO



CODE	DESCRIPTION	OEM REF.
KN1057	Repair kit hydraulic type Eos C25 EOS C25	144.130.291
KN1079	Kit o-ring cartridge type Eos (5 pieces)	150.040.339
KN1058	Repair kit Cartridge uppe Eos	144.130.205
KN1050	Gasket GT ø40mm	909.150.228
KN1051	Gasket GT ø28,6mm	909.150.207
KN1052	Gasket GT ø9,52mm	909.150.209
KN1038	Bellow (L) type EOS, F50	044.970.055
KN1056	Bellow (C) type 17A, 34A, 30S	144.890.208

COMPATIBLE with KREMLIN

# PUMPS SPARE PARTS

## PISTON PUMPS GASKETS



Gaskets kits for pneumatic piston pumps in different materials: PTFE, leather, high intensity polyethylene or polyurethane, compatible with **Binks, Anest Iwata, Graco, Wagner, Asturo, Falcioni and Larius**

CODE	DESCRIPTION	ØE - ØI - H
923012G	Leather gasket G30: 1 lower/upper	8-19,5-3,5
924512G	Leather gasket G45: 1 lower/upper	52-36-4,5
926012G	Leather gasket G60: 1 lower/upper	45-32-4
917402G	Leather gasket G74: 1 lower/upper	53-37-4
926812G	Leather gasket G68: 1 lower/upper	43-32-4
912301G	Ptfe gasket G23: 1 upper	21-13-3
912302G	Ptfe gasket G23: 1 lower	28-15-5
913012G	Ptfe gasket G30: 1 lower/upper	28-19,5-3,5
914512G	Ptfe gasket G45: 1 lower/upper	52-36-4,5
916012G	Ptfe gasket G60: 1 lower/upper	45-32-4
917401G	Ptfe gasket G74: 1 lower/upper	53-37-4
916812G	Ptfe gasket G68: 1 lower/upper	43-32-4

COMPATIBLE with GRACO

CODE	DESCRIPTION	ØE - ØI - H
913281	Ptfe gasket B 328 H lower	30-17-6
913282	Ptfe gasket B 328 H upper	25-12-6
914321	Ptfe gasket B 432 H lower	34-20-6
914322	Ptfe gasket B 432 H upper	27-14-5
916341	Ptfe gasket B 634/660 H lower	37-24-6
916342	Ptfe gasket B 634/660 H upper	30-17-6
911031	Ptfe gasket B 1032/1018 H lower	47-34-6
911032	Ptfe gasket B 1032/1018 H upper	37-24-6
912061	Ptfe gasket B 2066 H lower	47-34-6
912062	Ptfe gasket B 2066 H upper	37-24-6
912541	Ptfe gasket B 2548 H lower	53-39-6
912542	Ptfe gasket B 2548 H upper	41-28-6

CODE	DESCRIPTION	ØE - ØI - H
94482001T	Ptfe gasket type 48:200 lower	65-50-5,5
94482002	Pe gasket type 48:200 lower	65-50-5,5
94482003T	Ptfe gasket type 48:200 upper	50-35-5,5
94482004	Pe gasket type 48:200 upper	50-35-5

COMPATIBLE with WAGNER

## PISTON PUMPS GASKETS

COMPATIBLE with ASTURO

COMPATIBLE with FALCIONI

COMPATIBLE with LARIUS

COMPATIBLE with ANEST IWATA

CODE	DESCRIPTION	ØE - ØI - H
913012	Ptfe gasket type K 30 lower/upper	28-19,5-3,5
923012	Leather gasket type K 30 lower/upper	28-19,5-3,5
143080K	Gasket kit type K 30 lower/upper	

CODE	DESCRIPTION	ØE - ØI - H
912812	Ptfe gasket type FD 78:30 upper	28-14-4
913512	Ptfe gasket type FD 78:30 lower	35-19-4,5
912814	Ptfe gasket type FD 30 K upper	32,5-20-4
913514	Ptfe gasket type FD 30 K lower	40,5-28-4

CODE	DESCRIPTION	ØE - ØI - H
912301	Ptfe gasket type L 23 : 1 lower	21-13-3
912302	Ptfe gasket type L 23 : 1 upper	28-15-5
913001	Ptfe gasket type L 30 : 1 lower/upper	29-18-4,5
BBS1479	Ptfe gasket type L 40 : 1 lower/upper	24-16,5-4
914512	Ptfe gasket type L 45 : 1 lower/upper	50-35-5
916012	Ptfe gasket type L 60 : 1 lower/upper	46-32-5
916011	Ptfe gasket type L 60 : 1 lower/upper	46-32-5

CODE	DESCRIPTION	ØE - ØI - H
913312	Ptfe gasket type IW 331 upper	33-16-4
913311	Ptfe gasket type IW 331 lower	24-12-4
914312	Ptfe gasket type IW 431 upper	32-20-4
914311	Ptfe gasket type IW 431 lower	29-19-4
914332	Ptfe gasket type IW 433 lower	32-20-4
914331	Ptfe gasket type IW 433 lower	29-19-4
914332P	Peht gasket type IW 433 lower	32-20-4
914331P	Peht gasket type IW 433 lower	29-19-4



# PUMPS SPARE PARTS

## VALVES COMPATIBLE WAGNER



CODE	DESCRIPTION	OEM REF.
WA1015	Suction valve for Wagner SF21 - SF23	344700



CODE	DESCRIPTION	OEM REF.
WA1014	Suction valve for Wagner SF27 - SF31	341247



CODE	DESCRIPTION	OEM REF.
WA1016	Suction valve for F250, F270, SF21, SF23, SF27, SF31	341702

## VALVES - SUCTION VALVES



CODE	DESCRIPTION
400040	Aspiration valve 40 mm
400080	Aspiration valve 80 mm
400100	Aspiration valve 100 mm



CODE	DESCRIPTION	POS.
408080	Kit conical shutter	2-3-4
400082R	Shutter housing	1
400083R	Conical shutter	2
400084R	Shutter guide	3
400086R	Shutter spring/Nut and washer	4
400088R	Tubular gasket	5
400089R	Washer gasket	6

## VALVES - COMPRESSION VALVES



CODE	DESCRIPTION	POS.
400004	Compression valve ø11	1-8
400441R	Stainless steel cap	1
400442R	Copper gasket for cap	2
400443R	Spring for ball	3
400444R	Ball ø11	4
400445R	Gasket for ball housing	5
400446R	Ball housing	6
400447R	Ring for spring support	7
BBS1575	Tungsten carbide ball seat ø11	8



CODE	DESCRIPTION	POS.
400003	Compression valve ø14	1-8
400448R	Stainless steel cap	1
400449R	Copper gasket for cap	2
400443R	Spring for ball	3
400451R	Ball ø14	4
400452R	Gasket for ball housing	5
400453R	Ball housing	6
400447R	Ring for spring support	7
TR10619	Tungsten carbide ball seat ø14	8

# PUMPS SPARE PARTS

## VALVES - PRESSURE REGULATION VALVES



CODE	DESCRIPTION
400005	Pressure regulation valve complete
ORDZT7F	Gasket



CODE	DESCRIPTION
400300	Relief valve
ORDZT7F	Gasket

## HP VALVES



CODE	DESCRIPTION
023006	Stainless steel regulation valve M 1/4" x M 1/4"
023007	Stainless steel regulation valve M 1/4" x M 20x2

Max. pressure: 500 Bar/ 7250 Psi **STAINLESS STEEL**  
Adjustable closure with hard metal seat and ball



CODE	DESCRIPTION
023011	HP valve kit M1/4" x M20x2cm
023010	HP valve FF 1/4"
023015	HP valve FF 3/8"
023020	HP valve FF 1/2"
023025	HP valve FF 3/4"
023030	HP valve FF 1"

Max. pressure: 500 Bar/ 7250 Psi **STEEL**



CODE	DESCRIPTION
023012	Stainless steel HP valve kit M1/4" x M20x2cm
023054	Stainless steel HP valve FF 1/4"
023051	Stainless steel HP valve FF 3/8"
023052	Stainless steel HP valve FF 1/2"
023053	Stainless steel HP valve FF 3/4"

Max. pressure: 500 Bar/ 7250 Psi **STAINLESS STEEL**

# PUMPS SPARE PARTS

## HP VALVES



CODE	DESCRIPTION
023005	Steel mini HP valve FF 1/4"
023013	Steel mini HP valve kit M 1/4" x M 20x2cm

Max. pressure: 500 Bar/ 7250 Psi STEEL



CODE	DESCRIPTION
023050	Stainless steel mini HP valve FF 1/4"
023014	Stainless steel mini HP valve kit M 1/4" x M 20x2cm

Max. pressure: 500 Bar/ 7250 Psi STAINLESS STEEL



CODE	DESCRIPTION
023125	Steel 3 ways HP valve FFF 1/4"
023130	Steel 3 ways HP valve FFF 3/8"
023135	Steel 3 ways HP valve FFF 1/2"
023140	Steel 3 ways HP valve FFF 3/4"
023145	Steel 3 ways HP valve FFF 1"

Max. pressure: 400 Bar/ 4800 Psi STEEL



CODE	DESCRIPTION
023125I	Stainless steel 3 ways HP valve FFF 1/4"
023130I	Stainless steel 3 ways HP valve FFF 3/8"
023135I	Stainless steel 3 ways HP valve FFF 1/2"
023140I	Stainless steel 3 ways HP valve FFF 3/4"
023145I	Stainless steel 3 ways HP valve FFF 1"

Max. pressure: 400 Bar/ 4800 Psi STAINLESS STEEL

## LP VALVES



CODE	DESCRIPTION
383014	Ball valve FF 1/4"
383038	Ball valve FF 3/8"

Max. pressure: 24 Bar/348 Psi



CODE	DESCRIPTION
383114	Ball valve MF 1/4"
383138	Ball valve MF 3/8"

Max. pressure: 24 Bar/348 Psi



CODE	DESCRIPTION
BL3014I	Stainless steel low pressure ball valve FF 1/4"

Max. pressure: 24 Bar/348 Psi



CODE	DESCRIPTION
BL3014	Ball valve long grip FF 1/4"
BL3038	Ball valve long grip FF 3/8"
BL3012	Ball valve long grip FF 1/2"
BL3034	Ball valve long grip FF 3/4"
BL3010	Ball valve long grip FF 1"

Max. pressure: 24 Bar/348 Psi

# PUMPS SPARE PARTS

## NON RETURN VALVES



CODE	DESCRIPTION
VN1001I	Non-return valve FF 1/4" in STAINLESS STEEL
VN1001	Non-return valve FF 1/4"
VN1002	Non-return valve FF 3/8"
VN1003	Non-return valve FF 1/2"
VN1004	Non-return valve FF 3/4"



CODE	DESCRIPTION	L	HEX
TR664861	Stainless steel non-return valve M1/2" x M1/2"	91mm	27mm



CODE	DESCRIPTION	L	HEX
TR34655	Stainless steel non-return valve M16x1,5cm x M1/2"	72,50mm	27mm



CODE	DESCRIPTION	L	HEX
TT3146	Stainless steel non-return valve NPT x M3/8"	65mm	22mm



CODE	DESCRIPTION	L	HEX
TR23162	Stainless steel non-return valve M16x1,5cm x M1/2" GAS	40mm	24mm



CODE	DESCRIPTION	L	HEX
BBS1604	Stainless steel non-return valve M3/8" x M3/8" GAS	29mm	24mm

## ENGINE HEADS - VALVE EXCHANGERS - STROKE COMPENSATORS

### ENGINE HEADS



CODE	DESCRIPTION	POS.
790031R	Engine Head type Gold 10000	1
TKG6541	Engine Head type Gold 6500	2
710032R	Engine Head for B1000	3
790032R	Engine Head type Wagner 7000	4

### VALVE EXCHANGERS

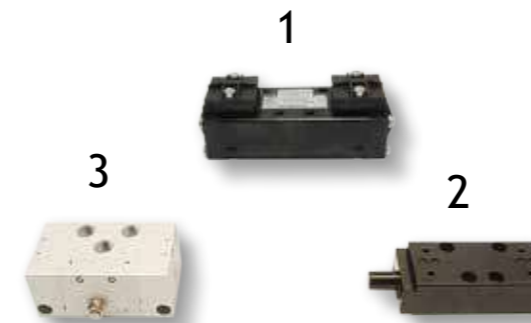

CODE	DESCRIPTION	POS.
212460R	Pneumatic valve exchanger type B24	1
242424R	Pneumatic valve exchanger type PM120-PM500	2
249051	Pneumatic valve exchanger type IW90 - IW120	3

### STROKE COMPENSATORS



CODE	DESCRIPTION
400800	Stroke compensator with connection

Connections: 1/4F x 1/4M

# PUMPS SPARE PARTS

## AIR REGULATORS



CODE	DESCRIPTION
PND060	Pressure regulator filter F 3/8"
PND070	Pressure regulator filter F 1/2"
BIT014	Pressure regulator filter F 1/4"



CODE	DESCRIPTION
PND080	Condensation filter F 1/4"
PND090	Condensation filter F 3/8"
PND100	Condensation filter F 1/2"
PND110	Condensation filter F 3/4"



CODE	DESCRIPTION
PND150	Lubricator F 3/8"
PND160	Lubricator F 1/2"



CODE	DESCRIPTION
BIT000	Pressure micro-regulator F 1/4"



CODE	DESCRIPTION
BIT018	Air inlet switcher

## AIR REGULATORS



CODE	DESCRIPTION
BIT015	Pressure regulator connection FF 1/4"



CODE	DESCRIPTION
BIT016	Pressure regulator connection FF 3/8"



CODE	DESCRIPTION
BIT017	Air ON/OFF valve



CODE	DESCRIPTION
KITREP	Double air regulator

# PUMPS SPARE PARTS

## MANOMETERS



CODE	DESCRIPTION
212486	Rear manometer ø50mm conn. 1/8"
212487	Radial manometer ø50mm conn. 1/8"

Max. pressure: 0-12 Bar 0-175 Psi  
Steel case - PA solvent resistant



CODE	DESCRIPTION
400963	Radial manometer ø63mm conn. 1/4"

Max. pressure: 0-6 Bar 0-87 Psi  
Steel case - PA solvent resistant



CODE	DESCRIPTION
212489	Rear manometer ø21mm conn. 1/8"

Max. pressure: 0-12 Bar 0-175 Psi  
Steel case - PA solvent resistant



CODE	DESCRIPTION
212488	Flanged manometer ø50mm conn. 1/8"

Max. pressure: 0-12 Bar 0-175 Psi  
Steel case - PA solvent resistant

## MANOMETERS



CODE	DESCRIPTION
130001	Radial manometer ø63mm conn. 1/4"
130002	Rear manometer ø63mm conn. 1/4"

Max. pressure: 0-400 Bar 0-5800 Psi  
Steel case - Pa solvent resistant



CODE	DESCRIPTION
130005	Rear manometer ø63mm conn. 1/4"

Max. pressure: 0-60 Bar 0-870 Psi  
Steel case - Pa solvent resistant



CODE	DESCRIPTION
130006	Rear manometer ø63mm conn. 1/4"

Max. pressure: 0-250 Bar 0-3625 Psi  
Steel case - Pa solvent resistant



CODE	DESCRIPTION
111305	Connection with manometer MF 16x1,5mm
111304	Connection with manometer MF 1/4"
110005	Connection without manometer MF 16x1,5mm
110004	Connection without manometer MF 1/4"
110025	Two-way connection MMF 16x1,5mm
110024	Two-way connection MMF 1/4"
110026	Three-way connection MMMF 16x1,5mm
130001	Manometer 400 Bar PA - radial connection
120003	Copper gasket for manometer

# PUMPS SPARE PARTS

## WHEELS



CODE	DESCRIPTION
RUOT16	Anti-puncture wheel Ø16
RUOT26	Anti-puncture wheel Ø26
RUOT26C	Anti-puncture wheel Ø26 Cover
RUOT40	Anti-puncture wheel Ø40



CODE	DESCRIPTION
RUOT21	Wheel Ø21
RUOT25	Wheel Ø25
RUOT40G	Wheel Ø40



CODE	DESCRIPTION
RUOT18	Turning wheel M8
RUOT30	Squared turning wheel
RUOT30F	Squared turning wheel with brake

## BALLS



Stainless steel balls

CODE	DESCRIPTION	SIZE
SFE006	Stainless steel ball 6mm	1/4"
SFE008	Stainless steel ball 8mm	5/16"
SFE010	Stainless steel ball 10mm	3/8"
SFE011	Stainless steel ball 11mm	7/16"
SFE012	Stainless steel ball 12mm	1/2"
SFE014	Stainless steel ball 14mm	9/16"
SFE016	Stainless steel ball 16mm	5/8"
SFE017	Stainless steel ball 17mm	11/16"
SFE019	Stainless steel ball 19mm	3/4"
SFE020	Stainless steel ball 20mm	13/16"
SFE022	Stainless steel ball 22mm	7/8"
SFE025	Stainless steel ball 25mm	1"
SFE028	Stainless steel ball 28mm	1" 1/8"
SFE030	Stainless steel ball 30mm	1" 3/16"
SFE032	Stainless steel ball 32mm	1" 1/4"
SFE035	Stainless steel ball 35mm	1" 3/8"
SFE038	Stainless steel ball 38mm	1" 1/2"



Delrin balls

CODE	DESCRIPTION	SIZE
SFE006D	Delrin ball 6mm	1/4"
SFE008D	Delrin ball 8mm	5/16"
SFE011D	Delrin ball 11mm	7/16"
SFE014D	Delrin ball 14mm	9/16"
SFE019D	Delrin ball 19mm	3/4"



Tungsten carbide balls

CODE	DESCRIPTION
SFE002CT	Tungsten carbide ball Ø2mm
SFE250CT	Tungsten carbide ball Ø2,5mm
SFE003CT	Tungsten carbide ball Ø3mm
SFE396CT	Tungsten carbide ball Ø3,96mm
SFE005CT	Tungsten carbide ball Ø5mm
SFE007CT	Tungsten carbide ball Ø7mm
400444R	Tungsten carbide ball Ø11mm
400451R	Tungsten carbide ball Ø14mm

## FLUID REGULATORS



*Berizzi produces and supplies high and low-pressure **fluid regulators** capable of maintaining a constant regulation of paint, mastic, liquid and fluid flow to increase productivity of the application and avoid accumulation of material.*

*Berizzi flow regulators guarantee accurate controls of the product used to respond to the flow rate required by the operator, keeping the paint spraying systems functioning more productively.*



# FLUID REGULATORS



CODE	DESCRIPTION
400970	Fluid pressure regulator 0-6Bar
400971	Repair kit for fluid pressure regulator

Max. press.: 0-6 Bar  
 Max. inlet press.: 20 Bar  
 Inlet fitting: 1/4"  
 Outlet fitting: 1/4"



CODE	DESCRIPTION
400980	Fluid pressure regulator 0-6Bar

Max. press.: 0-6 Bar  
 Max. inlet press.: 20 Bar  
 Inlet fitting: 3/8" or 1/4" with adapter  
 Outlet fitting: 1/4"



CODE	DESCRIPTION
400980I	Fluid pressure regulator 0-6Bar in STAINLESS STEEL with adapter

Max. press.: 0-6 Bar  
 Max. inlet press.: 20 Bar  
 Inlet fitting: 3/8" or 1/4" with adapter  
 Outlet fitting: 1/4"



CODE	DESCRIPTION
400960	Pneumatic fluid pressure regulator 0-6Bar

Max. press.: 0-6 Bar  
 Max. inlet press.: 20 Bar  
 Inlet fitting: 3/8" or 1/4" with adapter  
 Outlet fitting: 1/4"  
 Air hose inlet: Ø8



CODE	DESCRIPTION
400960I	Fluid pressure regulator 0-6Bar in STAINLESS STEEL

Max. press.: 0-6 Bar  
 Max. inlet press.: 20 Bar  
 Inlet fitting: 3/8" or 1/4" with adapter  
 Outlet fitting: 1/4"  
 Air hose inlet: Ø8



CODE	DESCRIPTION
TT12600	Fluid pressure regulator 0-25Bar
TT12600K	Fluid pressure regulator kit

Max. press.: 0-25 Bar  
 Max. inlet press.: 40 Bar  
 Inlet fitting: 1/4"  
 Outlet fitting: 1/4"



CODE	DESCRIPTION
400990	Fluid pressure regulator 30-300Bar

Max. press.: 30-300 Bar  
 Max. inlet press.: 400 Bar  
 Inlet fitting: F 3/8"  
 Outlet fitting: M 3/8"



CODE	DESCRIPTION
400900	Pneumatic fluid pressure regulator 30-300Bar

Max. press.: 30-300 Bar  
 Max. inlet press.: 400 Bar  
 Inlet fitting: F 3/8"  
 Outlet fitting: M 3/8"  
 Air hose inlet: Ø8

## MIXING AND HEATING



*Berizzi produces and supplies different accessories for mixing and heating fluids for professional paint spraying. Heating bands, liquid heaters and pneumatic agitators are available.*

1AM  
2AM  
4AM

page 196  
page 200  
page 202

# MIXING AND HEATING



TECHNICAL DATA	
Max. temperature	100°
Max. pressure	300 Bar
Power	2250 W
Power supply	230V/50Hz
Fittings	M 3/8" INOX
Product passage	stainless steel
Cable length	5 m
Weight	15 Kg

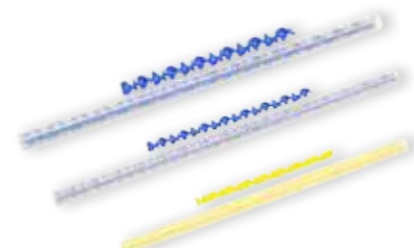

CODE	DESCRIPTION
FM66508	Static mixer Ø8 L. 290 mm
FM66510	Static mixer Ø10 L. 350 mm
FM66513	Static mixer Ø13 L. 380 mm



CODE	DESCRIPTION
FM67508	Hose rilsan mixer 8x1mm 1m F1/4" conn.
FM67510	Hose rilsan mixer 10x1mm 1m F1/4" conn.



CODE	DESCRIPTION
TR66310	TIG injector



CODE	DESCRIPTION
TR66311	6 MIX TIG injector



CODE	DESCRIPTION
RS0055	Fluid heater FENIX



CODE	DESCRIPTION
RS0056	Fluid heater FENIX on trolley





CODE	DESCRIPTION
FR200	Heating band 230V 50 Hz for 200L tank
FR300	Heating band 230V 50 Hz for 30L tank

# MIXING AND HEATING

1AM



CODE	DESCRIPTION
FM64001	Pneumatic stirrer 1AM with support
FM64002	Pneumatic stirrer 1AM without support
NG4007	Motor
NG4008	Shaft L 440mm propeller Ø72mm
BBS1435	Stirrer bush
BBS1719	Silencer
NG4009	Metal support
NG4010	Air regulator M1/8" x M1/4"

Min. H570mm - Max. H670mm   II 2GT6 X



TECHNICAL DATA	
Ø COVER	31cm
Ø SUCTION HOLE	5cm

CODE	DESCRIPTION
FM64005	Pneumatic stirrer 1AM with steel cover for tank
FM64002	Pneumatic stirrer 1AM without cover
BBS1599	Steel cover for tank

TECHNICAL DATA	
Ø COVER	31cm
RECYCLING FITTING	M1/4"
SUCTION FITTING	M1/2"
SUCTION LENGTH	50cm
STIRRER LENGTH	31cm
FILTER MESH	30M

CODE	DESCRIPTION
FM64009	Steel pneumatic stirrer 1AM on cover
BBS1885	Assembled cover without suction and stirrer



TECHNICAL DATA	
Ø COVER	36cm
Ø SUCTION HOLE	5cm

CODE	DESCRIPTION
FM64006	Pneumatic stirrer 1AM with steel cover for tank
FM64002	Pneumatic stirrer 1AM without cover
BBS1728	Steel cover for tank

NEW



TECHNICAL DATA	
Ø COVER	36cm
RECYCLING FITTING	M1/4"
SUCTION FITTING	M1/2"
SUCTION LENGTH	50cm
STIRRER LENGTH	31cm
FILTER MESH	30M

CODE	DESCRIPTION
FM64010	Steel pneumatic stirrer 1AM on cover
BBS1886	Assembled cover without suction and stirrer

# MIXING AND HEATING

1AM



CODE	DESCRIPTION
FM64007	Pneumatic stirrer 1AM with 6L white gravity tank
FM61000A	6L Gravity white tank
FM64007C	Cover with 1AM pneumatic stirrer for 6L gravity tank - white



CODE	DESCRIPTION
FM64008	Pneumatic stirrer 1AM with 6L black gravity tank
FM61000AB	6L Gravity black tank
FM64008C	Cover with 1AM pneumatic stirrer for 6L gravity tank - black



CODE	DESCRIPTION
BBS1541	Stainless steel pneumatic stirrer support for tank's cover

NEW



CODE	DESCRIPTION
212412	BOXER pneumatic double diaphragm pump fixed on cover for tanks with 1 AM pneumatic stirrer. C/ Inline filter - pressure reducer - cover handle - suction system with filter
FM64002	Pneumatic stirrer 1AM without cover

		BOXER
Ratio		1:1
Max. Delivery free flow	ltr/min	24
Max. Air inlet pressure	Bar (PSI)	8 (116)
Max. Working outlet pressure	Bar (PSI)	8 (116)
Air consumption	ltr/min	200-500
Material outlet fitting size		M 1/4"
Ø Cover		36cm



CODE	DESCRIPTION
212410	BOXER pneumatic double diaphragm pump fixed on cover for tanks with 1 AM pneumatic stirrer. C/ Inline filter - pressure reducer - cover handle - suction system with filter
FM64002	Pneumatic stirrer 1AM without cover

		BOXER
Ratio		1:1
Max. Delivery free flow	ltr/min	24
Max. Air inlet pressure	Bar (PSI)	8 (116)
Max. Working outlet pressure	Bar (PSI)	8 (116)
Air consumption	ltr/min	200-500
Material outlet fitting size		M 1/4"
Ø Cover		36cm

# MIXING AND HEATING

2AM



CODE	DESCRIPTION
205010	Pneumatic stirrer 2AM on tripod
205110	Pneumatic stirrer 2AM without tripod with propeller and shaft
205105	Air motor 2AM
205011	Propeller Ø 150mm
205012	Shaft (length 900mm)
205013	Tripod
205014	Stirrer bush

Min. H1000mm - Max. H1500mm II 2GT6 X

NEW



TECHNICAL DATA	
Ø COVER	31cm
RECYCLING FITTING	M1/4"
SUCTION FITTING	M1/2"
SUCTION LENGTH	50cm
STIRRER LENGTH	31cm
FILTER MESH	30M

CODE	DESCRIPTION
FM64011	Steel pneumatic stirrer 2AM on cover
BBS18852	Assembled cover without suction and stirrer

NEW



TECHNICAL DATA	
Ø COVER	36cm
RECYCLING FITTING	M1/4"
SUCTION FITTING	M1/2"
SUCTION LENGTH	50cm
STIRRER LENGTH	31cm
FILTER MESH	30M

CODE	DESCRIPTION
FM64012	Steel pneumatic stirrer 2AM on cover
BBS18862	Assembled cover



TECHNICAL DATA	
Ø COVER	61cm
Ø SUCTION HOLE	5cm

CODE	DESCRIPTION
205015	Pneumatic stirrer 2AM on steel cover



CODE	DESCRIPTION
212411	BOXER pneumatic double diaphragm pump fixed on cover for tanks with 2 AM pneumatic stirrer. C/ Inline filter - pressure reducer - cover handle - suction system with filter

		BOXER
Ratio		1:1
Max. Delivery free flow	ltr/min	24
Max. Air inlet pressure	Bar (PSI)	8 (116)
Max. Working outlet pressure	Bar (PSI)	8 (116)
Air consumption	ltr/min	200-500
Material outlet fitting size		M 1/4"
Ø Cover		61cm

NEW



CODE	DESCRIPTION
BBS1852	2AM-4AM pneumatic stirrer support

# MIXING AND HEATING

4AM

NEW



CODE	DESCRIPTION
205017	Pneumatic stirrer 4AM on tripod
205111	Pneumatic stirrer 4AM without tripod with propeller and shaft
205106	4AM air motor
205011	Stainless steel propeller ø150mm
205012	Shaft (L. 900mm)
205013	Trolley
205014	Stirrer bush

Min. H1000mm - Max. H1500mm II 2GT6 X

NEW



TECHNICAL DATA	
Ø COVER	31cm
RECYCLING FITTING	M1/4"
SUCTION FITTING	M1/2"
SUCTION LENGTH	50cm
STIRRER LENGTH	31cm
FILTER MESH	30M

CODE	DESCRIPTION
FM64013	Steel pneumatic stirrer 4AM on cover
BBS18852	Assembled cover without suction and stirrer

NEW



TECHNICAL DATA	
Ø COVER	36cm
RECYCLING FITTING	M1/4"
SUCTION FITTING	M1/2"
SUCTION LENGTH	50cm
STIRRER LENGTH	31cm
FILTER MESH	30M

CODE	DESCRIPTION
FM64014	Steel pneumatic stirrer 4AM on cover
BBS18862	Assembled cover

NEW



TECHNICAL DATA	
Ø COVER	61cm
Ø SUCTION HOLE	5cm

CODE	DESCRIPTION
205017	Pneumatic stirrer 4AM on steel cover

NEW



CODE	DESCRIPTION
212413	BOXER pneumatic double diaphragm pump fixed on cover for tanks with 4AM pneumatic stirrer. C/ Inline filter - pressure reducer - cover handle - suction system with filter

		BOXER
Ratio		1:1
Max. Delivery free flow	ltr/min	24
Max. Air inlet pressure	Bar (PSI)	8 (116)
Max. Working outlet pressure	Bar (PSI)	8 (116)
Air consumption	ltr/min	200-500
Material outlet fitting size		M 1/4"
Ø Cover		61cm

NEW



CODE	DESCRIPTION
BBS1852	2AM-4AM pneumatic stirrer support

# MIXING AND HEATING

NEW



CODE	DESCRIPTION
NG4007	1AM pneumatic stirrer motor
505105	2AM pneumatic stirrer motor
505106	4AM pneumatic stirrer motor

NEW



CODE	DESCRIPTION
FM64002	1AM pneumatic stirrer with shaft and marine propeller
205110	2AM pneumatic stirrer with shaft and marine propeller
205111	4AM pneumatic stirrer with shaft and marine propeller

NEW



CODE	DESCRIPTION	Ø PROPELLER
FM64002D	1AM pneu. stirrer with shaft and toothed propeller	80
205110D	2AM pneu. stirrer with shaft and toothed propeller	100
205111D	4AM pneu. stirrer with shaft and toothed propeller	150

NEW



CODE	DESCRIPTION
FM64002A	1AM pneumatic stirrer with shaft and extendable propeller
205110A	2AM pneumatic stirrer with shaft and extendable propeller
205111A	4AM pneumatic stirrer with shaft and extendable propeller

NEW



CODE	DESCRIPTION
BBS1903	Stirrer 2AM-4AM adapter for tanks



CODE	DESCRIPTION	ØI	ØE
NG4008B	Stainless steel propeller	12	75
205011	Stainless steel propeller	10	150
205017	Stainless steel propeller	16	150

**STAINLESS STEEL**  
**FIXING WITH LATERAL GRUB**

NEW

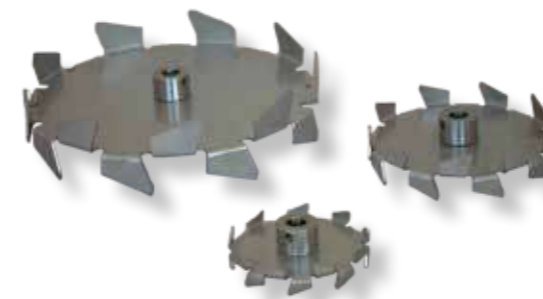

CODE	DESCRIPTION	ØI	ØE
BBS1916	Stainless steel toothed propeller	12	50
BBS1917	Stainless steel toothed propeller	16	50
BBS1918	Stainless steel toothed propeller	12	80
BBS1919	Stainless steel toothed propeller	16	80
BBS1894	Stainless steel toothed propeller	12	100
BBS1895	Stainless steel toothed propeller	16	100
BBS1920	Stainless steel toothed propeller	12	150
BBS1921	Stainless steel toothed propeller	16	150
BBS1922	Stainless steel toothed propeller	12	250
BBS1923	Stainless steel toothed propeller	16	250

**STAINLESS STEEL**  
**FIXING WITH LATERAL GRUB**



CODE	DESCRIPTION	ØI	ØE
BBS1888	S. steel extendable propeller for 200Lt tank	16	150
BBS1893	S. steel extendable propeller for 1000Lt tank	16	200

**STAINLESS STEEL**  
**FIXING WITH LATERAL GRUB**





*Berizzi produces and supplies pressurized stainless steel, galvanized steel and aluminum under pressure tanks, of different sizes and capacities, applicable to low-pressure paint spraying guns and the application of glues and sealants.*

## UNDER PRESSURE TANKS

# UNDER PRESSURE TANKS



CODE	DESCRIPTION
33200	FP2 Under pressure tank L 2 - full opening cover - material pressure regulator - 1 spray gun connection - suction material outlet
BB81005	Gasket for under pressure tank FP2 33200 <b>ALUMINUM</b>

**Air inlet connection:** M 1/4"  
**Air outlet connection:** M 1/4"  
**Material outlet connection:** M 1/4"  
**Max. pressure:** 4 Bar



CODE	DESCRIPTION
33300	FP8 Under pressure tank L 8 in stainless steel - handy opening cover - material pressure regulator - 1 spray gun connection - suction material outlet
GU3330*	Gasket for under pressure tank NBR FP8 33300
GU3330V	Gasket all solvents resistant for under pressure tank FP8 33300 <b>STAINLESS STEEL</b>

\*Base gasket GU3330 in NBR

**Bayonet air inlet connection**  
**Bayonet air outlet connection**  
**Material outlet connection:** M 3/8"  
**Max. pressure:** 2,6 Bar



CODE	DESCRIPTION
33500	FP10/1 Under pressure tank L 10 - full opening cover - material pressure regulator - 1 spray gun connection - suction material outlet
GU3350*	Gasket for under pressure tank FP10
GU3350C	Gasket for under pressure tank FP10 LEATHER <b>RISALNIZED STEEL</b>

\*Base gasket GU3350 in NBR

**Bayonet air inlet connection**  
**Bayonet air outlet connection**  
**Material outlet connection:** M 3/8"  
**Max. pressure:** 4 Bar



CODE	DESCRIPTION
33510	FP10/2 Under pressure tank L 10 - pneumatic stirrer 1AM - full opening cover - material pressure regulator - 1 spray gun connection - suction material outlet
GU3350*	Gasket for under pressure tank FP10
GU3350C	Gasket for under pressure tank FP10 LEATHER <b>RISALNIZED STEEL</b>

\*Base gasket GU3350 in NBR

**Bayonet air inlet connection**  
**Bayonet air outlet connection**  
**Material outlet connection:** M 3/8"  
**Max. pressure:** 4 Bar



CODE	DESCRIPTION
33520	FP10/3 Under pressure tank L 10 - pneumatic stirrer 1AM - full opening cover - material pressure regulator - 1 spray gun connection - lower material outlet F1/2"
GU3350*	Gasket for under pressure tank FP10
GU3350C	Gasket for under pressure tank FP10 LEATHER <b>RISALNIZED STEEL</b>

\*Base gasket GU3350 in NBR

**Bayonet air inlet connection**  
**Bayonet air outlet connection**  
**Material outlet connection:** M 3/8"  
**Max. pressure:** 4 Bar



CODE	DESCRIPTION
33400	FP16 Under pressure tank L 16 in stainless steel - handy opening cover - material pressure regulator - 1 spray gun connection - suction material outlet
GU3330*	Gasket for under pressure tank NBR FP16
GU3330V	Gasket all solvents resistant for under pressure tank FP16 <b>STAINLESS STEEL</b>

\*Base gasket GU3330 in NBR

**Bayonet air inlet connection**  
**Bayonet air outlet connection**  
**Material outlet connection:** M 3/8"  
**Max. pressure:** 2,6 Bar

# UNDER PRESSURE TANKS



CODE	DESCRIPTION
33720	FP24/ Under pressure tank L 24 - manual stirrer - full opening cover - material pressure regulator - 1 spray gun connection - lower material outlet F1/2"
GU3370*	Gasket for under pressure tank NBR FP24
GU3370C	Gasket for under pressure tank FP24 LEATHER
	<b>RISALNIZED STEEL</b>

\*Base gasket GU3370 in NBR

Bayonet air inlet connection  
 Bayonet air outlet connection  
 Material outlet connection: M 3/8"  
 Max. pressure: 4 Bar



CODE	DESCRIPTION
33700	FP24/3 Under pressure tank L 24 - manual stirrer-full opening cover - material double pressure regulator - 2 spray guns connection - suction two ways material outlet
GU3370*	Gasket for under pressure tank NBR FP24
GU3370C	Gasket for under pressure tank FP24 LEATHER
	<b>RISALNIZED STEEL</b>

\*Base gasket GU3370 in NBR

Bayonet air inlet connection  
 Bayonet air outlet connection  
 Material outlet connection: M 3/8"  
 Max. pressure: 4 Bar



CODE	DESCRIPTION
33730	FP24/2 Under pressure tank L 24 - manual stirrer - full opening cover - material pressure regulator - 1 spray gun connection - suction one way material outlet
GU3370*	Gasket for under pressure tank FP24
GU3370C	Gasket for under pressure tank FP24 LEATHER
	<b>RISALNIZED STEEL</b>

\*Base gasket GU3370 in NBR

Bayonet air inlet connection  
 Bayonet air outlet connection  
 Material outlet connection: M 3/8"  
 Max. pressure: 4 Bar



CODE	DESCRIPTION
33710	FP24/4 Under pressure tank L 24 - pneumatic stirrer 2AM - full opening cover - material double pressure regulator - 2 spray guns connection - suction two ways material outlet
GU3370*	Gasket for under pressure tank NBR FP24
GU3370C	Gasket for under pressure tank FP24
	<b>RISALNIZED STEEL</b>

\*Base gasket GU3370 in NBR

Bayonet air inlet connection  
 Bayonet air outlet connection  
 Material outlet connection: M 3/8"  
 Max. pressure: 4 Bar

## HOSES



*Berizzi supplies high and low-pressure hoses, suction hoses, springs, adapters and fittings in different sizes and alloys, air and solvent resistant hoses for different applications.*

*The hoses components are made with different metal alloys and plastic materials, compatible with the products of the main brands available on the market. Customization of measures, length and fittings as requested by the client.*

SUCTION SYSTEMS  
HIGH PRESSURE HOSES  
LOW PRESSURE HOSES

page 214  
page 222  
page 233



CODE	DESCRIPTION	Ø I	Ø E	WORKING PRESSURE	RADIUS	WEIGHT	REEL*	FERRULE CODE
		mm	mm	max. bar	min. mm	g/m	mt	
090913	Paintflex antistatic hose	13	22	10	68	280	61	BB1060
090916	Paintflex antistatic hose	16	24	10	85	300	61	on request
090919	Paintflex antistatic hose	19	28	10	100	480	61	BB1061
090925	Paintflex antistatic hose	25	36	10	125	880	61	BB1062
090930	Paintflex antistatic hose	30	41	10	145	983	61	BB1063

\*An additional cost of €5 net per product will be applied for cutting the entire reel on request.

On request graphic customization of the suction system with a minimum quantity. Length, size, connection and suction length customization on request.

**Technical-constructive features:** softwall hose with cross-linked polyethylene tube, suitable for handling varnish, lakes, inks and solvents.

**Working temperature:** -20°C(-4°F)+70°C(+158°F) depending on fluid used.

**Construction:**

Tube: black, smooth, cross-linked polyethylene (PE-X).

Reinforcement: high strength synthetic cord and antistatic copper wire.

Cover: black, smooth (wrapped finish), EPDM rubber, highly resistant to weathering and ozone.



### STEEL CONNECTION

CODE	DESCRIPTION	
690362	Suction pipe	F 36x2mm
693629	Suction pipe	F 36x2mm 90°
690034	Suction pipe	F 3/4"
690349	Suction pipe	F 3/4" 90°
690012	Suction pipe	F 1/2"
690129	Suction pipe	F 1/2" 90°
PAINTFLEX HOSE Ø13 - L750mm		
STAINLESS STEEL PIPE M15x1 L. 450mm - STEEL SEAL BALL		

CODE	DESCRIPTION	
69036212	Suction pipe	F 36x2mm
69362912	Suction pipe	F 36x2mm 90°
69003412	Suction pipe	F 3/4"
69034912	Suction pipe	F 3/4" 90°
69001212	Suction pipe	F 1/2"
69012912	Suction pipe	F 1/2" 90°
PAINTFLEX HOSE Ø19 - L750mm		
STAINLESS STEEL PIPE M1/2" L. 450mm - STEEL SEAL BALL		

CODE	DESCRIPTION	
680362	Suction pipe	F 36x2mm
683629	Suction pipe	F 36x2mm 90°
680001	Suction pipe	F 1"
680019	Suction pipe	F 1" 90°
PAINTFLEX HOSE Ø25 - L750mm		
STAINLESS STEEL PIPE M28x1,5 L. 450mm - STEEL SEAL BALL		

### S. STEEL CONNECTION

CODE	DESCRIPTION	
6903621	Suction pipe	F 36x2mm
6936291	Suction pipe	F 36x2mm 90°
6900341	Suction pipe	F 3/4"
6903491	Suction pipe	F 3/4" 90°
6900121	Suction pipe	F 1/2"
6901291	Suction pipe	F 1/2" 90°
PAINTFLEX HOSE Ø13 - L750mm		
S. STEEL M15x1 L. 450mm - S. STEEL SEAL BALL		

CODE	DESCRIPTION	
690362121	Suction pipe	F 36x2mm
693629121	Suction pipe	F 36x2mm 90°
690034121	Suction pipe	F 3/4"
690349121	Suction pipe	F 3/4" 90°
690012121	Suction pipe	F 1/2"
690129121	Suction pipe	F 1/2" 90°
PAINTFLEX HOSE Ø19 - L750mm		
S. STEEL M1/2" L. 450mm - S. STEEL SEAL BALL		

CODE	DESCRIPTION	
6803621	Suction pipe	F 36x2mm
6836291	Suction pipe	F 36x2mm 90°
6800011	Suction pipe	F 1"
6800191	Suction pipe	F 1" 90°
PAINTFLEX HOSE Ø25 - L750mm		
S. STEEL M28x1,5 L. 450mm - S. STEEL SEAL BALL		



STEEL CONNECTION

CODE	DESCRIPTION
6903624	Suction pipe F 36x2mm
6936294	Suction pipe F 36x2mm 90°
6900344	Suction pipe F 3/4"
6903494	Suction pipe F 3/4" 90°
6900124	Suction pipe F 1/2"
6901294	Suction pipe F 1/2" 90°
PAINTFLEX HOSE Ø13 - L1200mm	
STAINLESS STEEL PIPE M15x1 L. 450mm - STEEL SEAL BALL	

CODE	DESCRIPTION
69036512	Suction pipe F 36x2mm
69362512	Suction pipe F 36x2mm 90°
69003512	Suction pipe F 3/4"
69034512	Suction pipe F 3/4" 90°
PAINTFLEX HOSE Ø19 - L1200mm	
STAINLESS STEEL PIPE M1/2" L. 450mm - STEEL SEAL BALL	

CODE	DESCRIPTION
6803625	Suction pipe F 36x2mm
6836295	Suction pipe F 36x2mm 90°
6800015	Suction pipe F 1"
6800195	Suction pipe F 1" 90°
PAINTFLEX HOSE Ø25 - L1200mm	
STAINLESS STEEL PIPE M28x1,5 L. 450mm - STEEL SEAL BALL	

S. STEEL CONNECTION

CODE	DESCRIPTION
6903624I	Suction pipe F 36x2mm
6936294I	Suction pipe F 36x2mm 90°
6900344I	Suction pipe F 3/4"
6903494I	Suction pipe F 3/4" 90°
6900124I	Suction pipe F 1/2"
6901294I	Suction pipe F 1/2" 90°
PAINTFLEX HOSE Ø13 - L1200mm	
TUBO INOX M15x1 L. 450mm - S. STEEL SEAL BALL	

CODE	DESCRIPTION
69036512I	Suction pipe F 36x2mm
69362512I	Suction pipe F 36x2mm 90°
69003512I	Suction pipe F 3/4"
69034512I	Suction pipe F 3/4" 90°
PAINTFLEX HOSE Ø19 - L1200mm	
STAINLESS STEEL PIPE M1/2" L. 450mm - S. STEEL SEAL BALL	

CODE	DESCRIPTION
6803625I	Suction pipe F 36x2mm
6836295I	Suction pipe F 36x2mm 90°
6800015I	Suction pipe F 1"
6800195I	Suction pipe F 1" 90°
PAINTFLEX HOSE Ø25 - L1200mm	
STAINLESS STEEL PIPE M28x1,5 L. 450mm - S. STEEL SEAL BALL	



CODE	DESCRIPTION	OEM REF.
090014I	Suction hose Merkur M1/2" L500 / Paintflex Ø19mm L900	287258
090015I	Suction hose KN M 1/2" L500 / S. steel paintflex Ø19mm MT1 F26x125	149596110
090016I	Suction hose KN M 1" L900 / S. steel paintflex Ø25mm MT1,5 F38x150	151234011
090017I	Suction hose KN M 15x1,5 L500 / S. steel paintflex Ø13mm MT1 F18x25	149596010
090018I	Suction hose KN M 1/2" L900 / S. steel paintflex Ø19mm MT1 F26x125	149596010
090019I	Suction hose KN M1/2" L500 / S. steel paintflex Ø19mm MT1 F26x125 90°	
090020I	Suction hose KN M25x1" L500 / S. steel paintflex Ø19mm MT1 F26x125	149596150
090021I	Suction hose KN M18x1" L500 / S. steel paintflex Ø13mm MT1 F26x125	149596050
090022I	Suction hose KN M15x1,5 L500 / S. steel paintflex Ø13mm MT1 F26x125	
090024I	Suction hose KN M1" L500 / S. steel paintflex Ø25mm MT1 F1" Inox	663597900

CODE	DESCRIPTION	OEM REF.
090023	Suction hose KN M18x1" Ø13 F26x125 with 15 Mesh filter	149596040
FM20915	Suction filter F 18x1 15 Mesh	149596052

CODE	DESCRIPTION
610202	Throwback hose F 20x2
610229	Throwback hose F 20x2 90° PAINTFLEX HOSE Ø13 - L.750mm - STEEL SEAL BALL
6102025	Throwback hose F 20x2
6102295	Throwback hose F 20x2 90° PAINTFLEX HOSE Ø13 - L. 1200mm - STEEL SEAL BALL

CODE	DESCRIPTION
610202I	Stainless steel throwback hose F 20x2
610229I	Stainless steel throwback hose F 20x2 90° PAINTFLEX HOSE Ø13 - L. 750mm - S. STEEL SEAL BALL
6102025I	Stainless steel throwback hose F 20x2
6102295I	Stainless steel throwback hose F 20x2 90° PAINTFLEX HOSE Ø13 - L. 1200mm - S. STEEL SEAL BALL



CODE	DESCRIPTION
TUIN15	Stainless steel pipe Ø13 M 15x1 450mm with return hook
TUIN1550	Stainless steel pipe Ø13 M 15x1 500mm
TUIN1560	Stainless steel pipe Ø13 M 15x1 600mm
TUIN1590	Stainless steel pipe Ø13 M 15x1 900mm
TUIN15120	Stainless steel pipe Ø13 M 15x1 1200mm
TUIN12	Stainless steel pipe Ø19 M 1/2" 450mm with return hook
TUIN1250	Stainless steel pipe Ø19 M 1/2" 500mm
TUIN1260	Stainless steel pipe Ø19 M 1/2" 600mm
TUIN1270D	Stainless steel pipe Ø19 M 1/2" 450mm STRAIGHT
TUIN1290	Stainless steel pipe Ø19 M 1/2" 900mm
TUIN12120	Stainless steel pipe Ø19 M 1/2" 1200mm
TUIN28	Stainless steel pipe Ø25 M 28x1,5 450mm with return hook
TUIN2850O	Stainless steel pipe Ø25 M 28x1,5 500mm OBLIQUE
TUIN2860	Stainless steel pipe Ø25 M 28x1,5 600mm
TUIN2890	Stainless steel pipe Ø25 M 28x1,5 900mm
TUIN2890O	Stainless steel pipe Ø25 M 28x1,5 900mm OBLIQUE
TUIN28120	Stainless steel pipe Ø25 M 28x1,5 1200mm
TUIN150	Stainless steel pipe Ø30 M 1" 500mm
TUIN150O	Stainless steel pipe x Ø30 M 1" 500mm OBLIQUE
TUIN190	Stainless steel pipe Ø30 M 1" 900mm
TUIN190O	Stainless steel pipe x Ø30 M 1" 900mm OBLIQUE
TUIN1850	Stainless steel pipe Ø13 M 18x1 500mm
TUIN2550	Stainless steel pipe Ø19 M 25x1 500mm

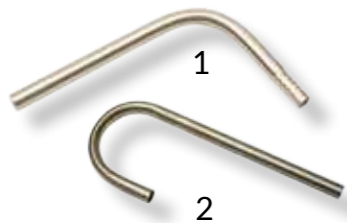

CODE	DESCRIPTION	POS.
TURINO	Stainless steel throwback pipe Ø15mm	1
TURINO2	Stainless steel throwback pipe Ø15mm	2



CODE	DESCRIPTION
BB1060	Suction hose ferrule Ø13mm
BB1061	Suction hose ferrule Ø19mm
BB1062	Suction hose ferrule Ø25mm
BB1063	Suction hose ferrule Ø30mm



CODE	DESCRIPTION
PRO028I	Stainless steel extension M 28x1,5 L. 50cm
PRO012I	Stainless steel extension M 1/2" L. 50cm
PRO015I	Stainless steel extension M 15x1 L. 50cm
002815	Coupling F 28x1,5
000012	Coupling F 1/2"
000151	Coupling F 15x1



CODE	DESCRIPTION
BBS1877	Non return valve M 28x1,5mm





# HOSES

## HIGH PRESSURE HOSES

### R7 TEXTILE BRAID HOSE

Standard fitting NPS  
Fittings available: NPT - BSP - JIC



Demonstrative detail of the hose internal section.  
N.B: hose color may change depending on stock availability

CODE	DESCRIPTION	Ø I	Ø E	WORKING PRESSURE	RADIUS	WEIGHT	REEL*	FERRULE CODE
		mm	mm	max. bar	mm	g/m	mt	
KT7532	R7 textile hose 5/32"	4	8,2	267	25	41	200	BB1096
KT7316	R7 textile hose 3/16"	4,8	10	280	35	68	200	BB1090
KT7014	R7 textile hose 1/4"	6,4	11,8	270	50	87	200	BB1091
KT7038	R7 textile hose 3/8"	9,7	16	260	75	146	150	BB1092
KT7012	R7 textile hose 1/2"	13	20,3	140	95	214	100	BB1093

\*An additional cost of €5 net per product will be applied for cutting the entire reel on request.

On request graphic customization of the suction system with a minimum quantity.

#### Technical-constructive features:

inner core in polyamide, polyester textile reinforcement and exterior covering in antiabrasion micro perforated polyurethane for the conduction of air and compatible gases. These hoses are not able to dissipate electrostatic charges that may build up in case non-conductive fluids are conveyed.

#### Application:

these R7 hoses series have been created for medium pressure conduction of polyols, solvents, paints and compatible gases.

#### Working temperature:

from -40°C to +100°C From -40°F to +212°F  
Max. working temperature of air, water and water-based fluids is + 95°C (+203°F).

#### Vacuum rating:

0,93 bar; 700 mm Hg

#### Specifications:

meet or exceed SAE J517 sez. SAE 100R7 - ISO 3949 standards.

## HIGH PRESSURE HOSES - R7 TEXTILE BRAID HOSE

### STEEL CONNECTION

CODE	DESCRIPTION	MT	CONNECTION
715054T	R7 textile hose 5/32"	mt 5	conn. 1/4"
715754T	R7 textile hose 5/32"	mt 7,5	conn. 1/4"
715104T	R7 textile hose 5/32"	mt 10	conn. 1/4"
715154T	R7 textile hose 5/32"	mt 15	conn. 1/4"
715204T	R7 textile hose 5/32"	mt 20	conn. 1/4"

STEEL CONN. - Hose 5/32" - Press. max. 200 Bar (Psi 2900)

CODE	DESCRIPTION	MT	CONNECTION
716054T	R7 textile hose 3/16"	mt 5	conn. 1/4"
716754T	R7 textile hose 3/16"	mt 7,5	conn. 1/4"
716104T	R7 textile hose 3/16"	mt 10	conn. 1/4"
716154T	R7 textile hose 3/16"	mt 15	conn. 1/4"
716204T	R7 textile hose 3/16"	mt 20	conn. 1/4"
716055T	R7 textile hose 3/16"	mt 5	conn. 16x1,5mm
716755T	R7 textile hose 3/16"	mt 7,5	conn. 16x1,5mm
716105T	R7 textile hose 3/16"	mt 10	conn. 16x1,5mm
716155T	R7 textile hose 3/16"	mt 15	conn. 16x1,5mm
716205T	R7 textile hose 3/16"	mt 20	conn. 16x1,5mm

STEEL CONN. - Hose 3/16" - Press. max. 280 Bar (Psi 4060)

CODE	DESCRIPTION	MT	CONNECTION
714054T	R7 textile hose 1/4"	mt 5	conn. 1/4"
714754T	R7 textile hose 1/4"	mt 7,5	conn. 1/4"
714104T	R7 textile hose 1/4"	mt 10	conn. 1/4"
714154T	R7 textile hose 1/4"	mt 15	conn. 1/4"
714204T	R7 textile hose 1/4"	mt 20	conn. 1/4"
714055T	R7 textile hose 1/4"	mt 5	conn. 16x1,5mm
714755T	R7 textile hose 1/4"	mt 7,5	conn. 16x1,5mm
714105T	R7 textile hose 1/4"	mt 10	conn. 16x1,5mm
714155T	R7 textile hose 1/4"	mt 15	conn. 16x1,5mm
714205T	R7 textile hose 1/4"	mt 20	conn. 16x1,5mm
714058T	R7 textile hose 1/4"	mt 5	conn. 3/8"
714758T	R7 textile hose 1/4"	mt 7,5	conn. 3/8"
714108T	R7 textile hose 1/4"	mt 10	conn. 3/8"
714158T	R7 textile hose 1/4"	mt 15	conn. 3/8"
714208T	R7 textile hose 1/4"	mt 20	conn. 3/8"

STEEL CONN. - Hose 1/4" - Press. max. 270 Bar (Psi 3915)

CODE	DESCRIPTION	MT	CONNECTION
738055T	R7 textile hose 3/8"	mt 5	conn. 16x1,5mm
738755T	R7 textile hose 3/8"	mt 7,5	conn. 16x1,5mm
738105T	R7 textile hose 3/8"	mt 10	conn. 16x1,5mm
738155T	R7 textile hose 3/8"	mt 15	conn. 16x1,5mm
738205T	R7 textile hose 3/8"	mt 20	conn. 16x1,5mm
738058T	R7 textile hose 3/8"	mt 5	conn. 3/8"
738758T	R7 textile hose 3/8"	mt 7,5	conn. 3/8"
738108T	R7 textile hose 3/8"	mt 10	conn. 3/8"
738158T	R7 textile hose 3/8"	mt 15	conn. 3/8"
738208T	R7 textile hose 3/8"	mt 20	conn. 3/8"

STEEL CONN. - Hose 3/8" - Press. max. 260 Bar (Psi 3770)

### S. STEEL CONNECTION

CODE	DESCRIPTION	MT	CONNECTION
6715054T	R7 textile hose 5/32"	mt 5	conn. 1/4"
6715754T	R7 textile hose 5/32"	mt 7,5	conn. 1/4"
6715104T	R7 textile hose 5/32"	mt 10	conn. 1/4"
6715154T	R7 textile hose 5/32"	mt 15	conn. 1/4"
6715204T	R7 textile hose 5/32"	mt 20	conn. 1/4"

STAINLESS STEEL CONN. - Hose 5/32" - Press. max. 200 Bar (Psi 2900)

CODE	DESCRIPTION	MT	CONNECTION
6716054T	R7 textile hose 3/16"	mt 5	conn. 1/4"
6716754T	R7 textile hose 3/16"	mt 7,5	conn. 1/4"
6716104T	R7 textile hose 3/16"	mt 10	conn. 1/4"
6716154T	R7 textile hose 3/16"	mt 15	conn. 1/4"
6716204T	R7 textile hose 3/16"	mt 20	conn. 1/4"
6716055T	R7 textile hose 3/16"	mt 5	conn. 16x1,5mm
6716755T	R7 textile hose 3/16"	mt 7,5	conn. 16x1,5mm
6716105T	R7 textile hose 3/16"	mt 10	conn. 16x1,5mm
6716155T	R7 textile hose 3/16"	mt 15	conn. 16x1,5mm
6716205T	R7 textile hose 3/16"	mt 20	conn. 16x1,5mm

STAINLESS STEEL CONN. - Hose 3/16" - Press. max. 280 Bar (Psi 4060)

CODE	DESCRIPTION	MT	CONNECTION
6714054T	R7 textile hose 1/4"	mt 5	conn. 1/4"
6714754T	R7 textile hose 1/4"	mt 7,5	conn. 1/4"
6714104T	R7 textile hose 1/4"	mt 10	conn. 1/4"
6714154T	R7 textile hose 1/4"	mt 15	conn. 1/4"
6714204T	R7 textile hose 1/4"	mt 20	conn. 1/4"
6714055T	R7 textile hose 1/4"	mt 5	conn. 16x1,5mm
6714755T	R7 textile hose 1/4"	mt 7,5	conn. 16x1,5mm
6714105T	R7 textile hose 1/4"	mt 10	conn. 16x1,5mm
6714155T	R7 textile hose 1/4"	mt 15	conn. 16x1,5mm
6714205T	R7 textile hose 1/4"	mt 20	conn. 16x1,5mm
6714058T	R7 textile hose 1/4"	mt 5	conn. 3/8"
6714758T	R7 textile hose 1/4"	mt 7,5	conn. 3/8"
6714108T	R7 textile hose 1/4"	mt 10	conn. 3/8"
6714158T	R7 textile hose 1/4"	mt 15	conn. 3/8"
6714208T	R7 textile hose 1/4"	mt 20	conn. 3/8"

STAINLESS STEEL CONN. - Hose 1/4" - Press. max. 270 Bar (Psi 3915)

CODE	DESCRIPTION	MT	CONNECTION
6738055T	R7 textile hose 3/8"	mt 5	conn. 16x1,5mm
6738755T	R7 textile hose 3/8"	mt 7,5	conn. 16x1,5mm
6738105T	R7 textile hose 3/8"	mt 10	conn. 16x1,5mm
6738155T	R7 textile hose 3/8"	mt 15	conn. 16x1,5mm
6738205T	R7 textile hose 3/8"	mt 20	conn. 16x1,5mm
6738058T	R7 textile hose 3/8"	mt 5	conn. 3/8"
6738758T	R7 textile hose 3/8"	mt 7,5	conn. 3/8"
6738108T	R7 textile hose 3/8"	mt 10	conn. 3/8"
6738158T	R7 textile hose 3/8"	mt 15	conn. 3/8"
6738208T	R7 textile hose 3/8"	mt 20	conn. 3/8"

STAINLESS STEEL CONN. - Hose 3/8" - Press. max. 260 Bar (Psi 3770)

# HOSES

## HIGH PRESSURE HOSES

### R7 ANTISTATIC TEXTILE HOSE



Standard fitting NPS  
Fittings available: NPT - BSP - JIC

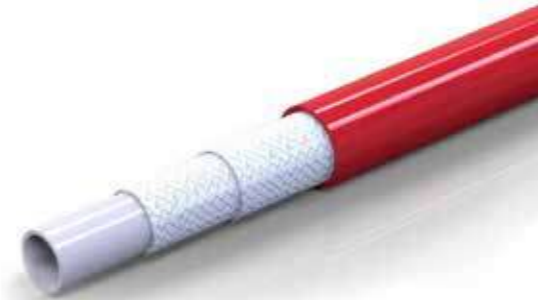

Demonstrative detail of the hose internal section.  
N.B: hose color may change depending on stock availability

CODE	DESCRIPTION	Ø I	Ø E	WORKING PRESSURE	RADIUS	WEIGHT	REEL*	FERRULE CODE
		mm	mm	max. bar	min. mm	g/m	mt	
BB7104	HP antistatic R7 hose 3/16"	4,8	10,5	333	30	75	on request	BB1096
BB7106	HP antistatic R7 hose 1/4"	6,4	12,7	304	40	102	on request	BB1090

\*An additional cost of €5 net per product will be applied for cutting the entire reel on request.

On request graphic customization of the suction system with a minimum quantity.

#### Technical-constructive features:

inner core in polyamide, polyester textile double braid reinforcement, external covering in antiabrasion micro perforated polyurethane for the conduction of air and compatible gases. The hose's electrical resistance is less than  $3 \times 10^4 \Omega/m$  in accordance with ISO 8031 Standard.

#### Application:

these R7 hoses series have been created for medium pressure conduction of polyols, solvents, paints and compatible gases.

#### Working temperature:

from -40° C to +100° C From -40° F to +212° F  
Max. working temperature of air, water and water-based fluids is +95° C (+203° F).

#### Vacuum rating:

0,93 bar; 700 mm Hg

#### Specifications:

meet or exceed SAE J517 sez. SAE 100R7 - ISO 3949 standards.

## HIGH PRESSURE HOSES - R7 ANTISTATIC TEXTILE HOSE

CODE	DESCRIPTION	MT	CONNECTION
6616054T	HTA R7 hose 3/16"	mt 5	conn. 1/4"
6616754T	HTA R7 hose 3/16"	mt 7,5	conn. 1/4"
6616104T	HTA R7 hose 3/16"	mt 10	conn. 1/4"
6616154T	HTA R7 hose 3/16"	mt 15	conn. 1/4"
6616204T	HTA R7 hose 3/16"	mt 20	conn. 1/4"
6616055T	HTA R7 hose 3/16"	mt 5	conn 16x1,5mm
6616755T	HTA R7 hose 3/16"	mt 7,5	conn 16x1,5mm
6616105T	HTA R7 hose 3/16"	mt 10	conn 16x1,5mm
6616155T	HTA R7 hose 3/16"	mt 15	conn 16x1,5mm
6616205T	HTA R7 hose 3/16"	mt 20	conn 16x1,5mm

STEEL CONNECTION - Hose 3/16" - Press. max: 270 Bar (Psi 3915)

CODE	DESCRIPTION	MT	CONNECTION
6614054T	HTA R7 hose 1/4"	mt 5	conn. 1/4"
6614754T	HTA R7 hose 1/4"	mt 7,5	conn. 1/4"
6614104T	HTA R7 hose 1/4"	mt 10	conn. 1/4"
6614154T	HTA R7 hose 1/4"	mt 15	conn. 1/4"
6614204T	HTA R7 hose 1/4"	mt 20	conn. 1/4"
6614055T	HTA R7 hose 1/4"	mt 5	conn 16x1,5mm
6614755T	HTA R7 hose 1/4"	mt 7,5	conn 16x1,5mm
6614105T	HTA R7 hose 1/4"	mt 10	conn 16x1,5mm
6614155T	HTA R7 hose 1/4"	mt 15	conn 16x1,5mm
6614205T	HTA R7 hose 1/4"	mt 20	conn 16x1,5mm

STEEL CONNECTION - Hose 1/4" - Press. max: 260 Bar (Psi 3770)

# HOSES

## HIGH PRESSURE HOSES

### SINGLE METAL BRAID HOSE



Standard fitting NPS  
Fittings available: NPT - BSP - JIC



Demonstrative detail of the hose internal section.  
N.B: hose color may change depending on stock availability

CODE	DESCRIPTION	ØI	ØE	WORKING PRESSURE	RADIUS	WEIGHT	REEL*	FERRULE CODE
		mm	mm	max. bar	min. mm	g/m	mt	
616000	HP hose 3/16"	4,8	10	450	30	131	200	BB1090
614000	HP hose 1/4"	6,4	11,9	400	40	165	200	BB1091
638000	HP hose 3/8"	9,7	16	300	60	253	150	BB1092
612000	HP hose 1/2"	13	19,2	190	75	314	100	BB1093
603400	HP hose 3/4"	19,2	25,5	130	150	447	on request	BB1094
610000	HP hose 1"	25,6	32,5	105	185	590	on request	BB1095

\*An additional cost of €5 net per product will be applied for cutting the entire reel on request.

On request graphic customization of the suction system with a minimum quantity.

#### Technical-constructive features:

inner core in polyamide, reinforcement in double high tensile steel braid and exterior covering in antiabrasion polyurethane, micro perforated on request for the conduction of air and compatible gases.

#### Application:

these HP hoses series have been created for medium pressure conduction of polyols, solvents, paints and compatible gases.

#### Working temperature:

from -40° C to +100° C From -40° F to +212° F  
Max. working temperature of air, water and water-based fluids is + 95° C (+203° F).

#### Vacuum rating:

0,93 bar; 700 mm Hg

#### Specifications:

meet or exceed SAE 100R1 - EN 853 1ST, 1SN - EN 857 1SC standards.

## HIGH PRESSURE HOSES - SINGLE METAL BRAID HOSE

### STEEL CONNECTION

CODE	DESCRIPTION	MT	CONNECTION
616054	HP hose 3/16"	mt 5	conn. 1/4"
616754	HP hose 3/16"	mt 7,5	conn. 1/4"
616104	HP hose 3/16"	mt 10	conn. 1/4"
616154	HP hose 3/16"	mt 15	conn. 1/4"
616204	HP hose 3/16"	mt 20	conn. 1/4"
616055	HP hose 3/16"	mt 5	conn. 16x1,5mm
616755	HP hose 3/16"	mt 7,5	conn. 16x1,5mm
616105	HP hose 3/16"	mt 10	conn. 16x1,5mm
616155	HP hose 3/16"	mt 15	conn. 16x1,5mm
616205	HP hose 3/16"	mt 20	conn. 16x1,5mm

STEEL CONN. - Hose 3/16" - Press. max: 450 Bar (Psi 6526)

### S. STEEL CONNECTION

CODE	DESCRIPTION	MT	CONNECTION
6616054	HP hose 3/16"	mt 5	conn. 1/4"
6616754	HP hose 3/16"	mt 7,5	conn. 1/4"
6616104	HP hose 3/16"	mt 10	conn. 1/4"
6616154	HP hose 3/16"	mt 15	conn. 1/4"
6616204	HP hose 3/16"	mt 20	conn. 1/4"
6616055	HP hose 3/16"	mt 5	conn. 16x1,5mm
6616755	HP hose 3/16"	mt 7,5	conn. 16x1,5mm
6616105	HP hose 3/16"	mt 10	conn. 16x1,5mm
6616155	HP hose 3/16"	mt 15	conn. 16x1,5mm
6616205	HP hose 3/16"	mt 20	conn. 16x1,5mm

S. STEEL CONN. - Hose 3/16" - Press. max: 450 Bar (Psi 6526)

CODE	DESCRIPTION	MT	CONNECTION
614054	HP hose 1/4"	mt 5	conn. 1/4"
614754	HP hose 1/4"	mt 7,5	conn. 1/4"
614104	HP hose 1/4"	mt 10	conn. 1/4"
614154	HP hose 1/4"	mt 15	conn. 1/4"
614204	HP hose 1/4"	mt 20	conn. 1/4"
614304	HP hose 1/4"	mt 30	conn. 1/4"
614055	HP hose 1/4"	mt 5	conn. 16x1,5mm
614755	HP hose 1/4"	mt 7,5	conn. 16x1,5mm
614105	HP hose 1/4"	mt 10	conn. 16x1,5mm
614155	HP hose 1/4"	mt 15	conn. 16x1,5mm
614205	HP hose 1/4"	mt 20	conn. 16x1,5mm
614305	HP hose 1/4"	mt 30	conn. 16x1,5mm
614758	HP hose 1/4"	mt 7,5	conn. 3/8"
614108	HP hose 1/4"	mt 10	conn. 3/8"
614158	HP hose 1/4"	mt 15	conn. 3/8"
614208	HP hose 1/4"	mt 20	conn. 3/8"

STEEL CONN. - Hose 1/4" - Press. max: 400 Bar (Psi 5800)

CODE	DESCRIPTION	MT	CONNECTION
6614054	HP hose 1/4"	mt 5	conn. 1/4"
6614754	HP hose 1/4"	mt 7,5	conn. 1/4"
6614104	HP hose 1/4"	mt 10	conn. 1/4"
6614154	HP hose 1/4"	mt 15	conn. 1/4"
6614204	HP hose 1/4"	mt 20	conn. 1/4"
6614304	HP hose 1/4"	mt 30	conn. 1/4"
6614055	HP hose 1/4"	mt 5	conn. 16x1,5mm
6614755	HP hose 1/4"	mt 7,5	conn. 16x1,5mm
6614105	HP hose 1/4"	mt 10	conn. 16x1,5mm
6614155	HP hose 1/4"	mt 15	conn. 16x1,5mm
6614205	HP hose 1/4"	mt 20	conn. 16x1,5mm
6614305	HP hose 1/4"	mt 30	conn. 16x1,5mm
6614758	HP hose 1/4"	mt 7,5	conn. 3/8"
6614108	HP hose 1/4"	mt 10	conn. 3/8"
6614158	HP hose 1/4"	mt 15	conn. 3/8"
6614208	HP hose 1/4"	mt 20	conn. 3/8"

S. STEEL CONN. - Hose 1/4" - Press. max: 400 Bar (Psi 5800)

CODE	DESCRIPTION	MT	CONNECTION
638055	HP hose 3/8"	mt 5	conn. 16x1,5mm
638755	HP hose 3/8"	mt 7,5	conn. 16x1,5mm
638105	HP hose 3/8"	mt 10	conn. 16x1,5mm
638155	HP hose 3/8"	mt 15	conn. 16x1,5mm
638205	HP hose 3/8"	mt 20	conn. 16x1,5mm
638058	HP hose 3/8"	mt 5	conn. 3/8"
638758	HP hose 3/8"	mt 7,5	conn. 3/8"
638108	HP hose 3/8"	mt 10	conn. 3/8"
638158	HP hose 3/8"	mt 15	conn. 3/8"
638208	HP hose 3/8"	mt 20	conn. 3/8"

STEEL CONN. - Hose 3/8" - Press. max: 300 Bar (Psi 4350)

CODE	DESCRIPTION	MT	CONNECTION
6638055	HP hose 3/8"	mt 5	conn. 16x1,5mm
6638755	HP hose 3/8"	mt 7,5	conn. 16x1,5mm
6638105	HP hose 3/8"	mt 10	conn. 16x1,5mm
6638155	HP hose 3/8"	mt 15	conn. 16x1,5mm
6638205	HP hose 3/8"	mt 20	conn. 16x1,5mm
6638058	HP hose 3/8"	mt 5	conn. 3/8"
6638758	HP hose 3/8"	mt 7,5	conn. 3/8"
6638108	HP hose 3/8"	mt 10	conn. 3/8"
6638158	HP hose 3/8"	mt 15	conn. 3/8"
6638208	HP hose 3/8"	mt 20	conn. 3/8"

S. STEEL CONN. - Hose 3/8" - Press. max: 300 Bar (Psi 4350)

# HOSES

## HIGH PRESSURE HOSES

### DOUBLE METAL BRAID

Standard fitting NPS  
Fittings available: NPT - BSP - JIC



Demonstrative detail of the hose internal section.  
N.B: hose color may change depending on stock availability

CODE	DESCRIPTION	ØI	ØE	WORKING PRESSURE	RADIUS	WEIGHT	REEL*	FERRULE CODE
		mm	mm	max. bar	min. mm	g/m	mt	
B206	HP hose 1/4"	6,4	13,5	500	40	286	150	BB1091D
B210	HP hose 3/8"	9,7	17	500	60	408	150	BB1092D
B212	HP hose 1/2"	13	22	500	75	582	150	BB1093D
B219	HP hose 3/4"	19,2	27,5	160	150	765	on request	BB1094D
B225	HP hose 1"	25,6	35	150	185	1026	on request	BB1095D

\*An additional cost of €5 net per product will be applied for cutting the entire reel on request.

On request graphic customization of the suction system with a minimum quantity.

#### Technical-constructive features:

inner core in polyamide, reinforcement in double high tensile steel braid and exterior covering in antiabrasion polyurethane, micro perforated on request for the conduction of air and compatible gases.

#### Application:

these hoses have been created for the high pressure conduction of polyols, solvents and paints and compatible gases, in chemically aggressive environments

#### Working temperature:

from -40° C to +100° C From -40° F to +212° F  
Max. working temperature of air, water and water-based fluids is + 95° C (+203° F).

#### Vacuum rating:

0.93 bar; 700 mm Hg

#### Specifications:

meet or exceed SAE 100R2 - SAE J517-100R2 standards.

## HIGH PRESSURE HOSES - DOUBLE METAL BRAID

### STEEL CONNECTION

CODE	DESCRIPTION	MT	CONNECTION
6140542	HP2 hose 1/4"	mt 5	conn. 1/4"
6147542	HP2 hose 1/4"	mt 7,5	conn. 1/4"
6141042	HP2 hose 1/4"	mt 10	conn. 1/4"
6141542	HP2 hose 1/4"	mt 15	conn. 1/4"
6142042	HP2 hose 1/4"	mt 20	conn. 1/4"
6140552	HP2 hose 1/4"	mt 5	conn. 16x1,5mm
6147552	HP2 hose 1/4"	mt 7,5	conn. 16x1,5mm
6141052	HP2 hose 1/4"	mt 10	conn. 16x1,5mm
6141552	HP2 hose 1/4"	mt 15	conn. 16x1,5mm
6142052	HP2 hose 1/4"	mt 20	conn. 16x1,5mm
6140582	HP2 hose 1/4"	mt 5	conn. 3/8"
6147582	HP2 hose 1/4"	mt 7,5	conn. 3/8"
6141082	HP2 hose 1/4"	mt 10	conn. 3/8"
6141582	HP2 hose 1/4"	mt 15	conn. 3/8"
6142082	HP2 hose 1/4"	mt 20	conn. 3/8"

STEEL CONN. - Hose 1/4" - Press. max: 500 Bar (Psi 7250)

### S. STEEL CONNECTION

CODE	DESCRIPTION	MT	CONNECTION
66140542	HP2 hose 1/4"	mt 5	conn. 1/4"
66147542	HP2 hose 1/4"	mt 7,5	conn. 1/4"
66141042	HP2 hose 1/4"	mt 10	conn. 1/4"
66141542	HP2 hose 1/4"	mt 15	conn. 1/4"
66142042	HP2 hose 1/4"	mt 20	conn. 1/4"
66140552	HP2 hose 1/4"	mt 5	conn. 16x1,5mm
66147552	HP2 hose 1/4"	mt 7,5	conn. 16x1,5mm
66141052	HP2 hose 1/4"	mt 10	conn. 16x1,5mm
66141552	HP2 hose 1/4"	mt 15	conn. 16x1,5mm
66142052	HP2 hose 1/4"	mt 20	conn. 16x1,5mm
66140582	HP2 hose 1/4"	mt 5	conn. 3/8"
66147582	HP2 hose 1/4"	mt 7,5	conn. 3/8"
66141082	HP2 hose 1/4"	mt 10	conn. 3/8"
66141582	HP2 hose 1/4"	mt 15	conn. 3/8"
66142082	HP2 hose 1/4"	mt 20	conn. 3/8"

S. STEEL CONN. - Hose 1/4" - Press. max: 500 Bar (Psi 7250)

CODE	DESCRIPTION	MT	CONNECTION
6380552	HP2 hose 3/8"	mt 5	conn. 16x1,5mm
6387552	HP2 hose 3/8"	mt 7,5	conn. 16x1,5mm
6381052	HP2 hose 3/8"	mt 10	conn. 16x1,5mm
6381552	HP2 hose 3/8"	mt 15	conn. 16x1,5mm
6382052	HP2 hose 3/8"	mt 20	conn. 16x1,5mm
6380582	HP2 hose 3/8"	mt 5	conn. 3/8"
6387582	HP2 hose 3/8"	mt 7,5	conn. 3/8"
6381082	HP2 hose 3/8"	mt 10	conn. 3/8"
6381582	HP2 hose 3/8"	mt 15	conn. 3/8"
6382082	HP2 hose 3/8"	mt 20	conn. 3/8"
6383082	HP2 hose 3/8"	mt 30	conn. 3/8"

STEEL CONN. - Hose 3/8" - Press. max: 500 Bar (Psi 7250)

CODE	DESCRIPTION	MT	CONNECTION
66380552	HP2 hose 3/8"	mt 5	conn. 16x1,5mm
66387552	HP2 hose 3/8"	mt 7,5	conn. 16x1,5mm
66381052	HP2 hose 3/8"	mt 10	conn. 16x1,5mm
66381552	HP2 hose 3/8"	mt 15	conn. 16x1,5mm
66382052	HP2 hose 3/8"	mt 20	conn. 16x1,5mm
66380582	HP2 hose 3/8"	mt 5	conn. 3/8"
66387582	HP2 hose 3/8"	mt 7,5	conn. 3/8"
66381082	HP2 hose 3/8"	mt 10	conn. 3/8"
66381582	HP2 hose 3/8"	mt 15	conn. 3/8"
66382082	HP2 hose 3/8"	mt 20	conn. 3/8"
66383082	HP2 hose 3/8"	mt 30	conn. 3/8"

S. STEEL CONN. - Hose 3/8" - Press. max: 500 Bar (Psi 7250)

# HOSES

## HIGH PRESSURE HOSES

### PTFE SINGLE METAL BRAID HOSE



Demonstrative detail of the hose internal section.  
N.B: hose color may change depending on stock availability

CODE	DESCRIPTION	Ø I	Ø E	WORKING PRESSURE	RADIUS	WEIGHT	FERRULE CODE
		mm	mm	max. bar	min. mm	g/m	
PTFE104	PTFE single metal braid 3/16"	4,8	7,4	200	35	69	BB1090
PTFE106	PTFE single metal braid 1/4"	6,35	8,9	175	45	87	BB1091
PTFE110	PTFE single metal braid 3/8"	9,5	12,4	135	55	145	BB1092
PTFE112	PTFE single metal braid 1/2"	12,7	12	120	70	212	BBR26
PTFE119	PTFE single metal braid 3/4"	19	22,2	90	190	321	BBR73
PTFE125	PTFE single metal braid 1"	25,4	29,3	65	270	450	BBR74

**SINGLE EXTERNAL METAL BRAID**

#### Technical-constructive features:

inner core in PTFE with double AISI 304 stainless steel reinforcement braid.

#### Application:

These hoses in PTFE have been created mainly for the high pressure conduction of paints, oils, air, food and steam. They do not dissipate electrostatic charges when conveying non-conductive fluids.

#### Working temperature:

From -60° C to +260° C From -76° F to +500° F

#### Specifications:

Reg. EU 1935/2004, Reg. EU 10/2011. Simulants A, B, C and D1. Standardised testing conditions OM6. Simulant D2 testing conditions OM7. FDA 21 CFR 177.1550  
Italian D.M. 174 of 06/04/2004 for use in drinking water supply chain.

## HIGH PRESSURE HOSES

### PTFE DOUBLE METAL BRAID HOSE



Demonstrative detail of the hose internal section.  
N.B: hose color may change depending on stock availability

CODE	DESCRIPTION	Ø I	Ø E	WORKING PRESSURE	RADIUS	WEIGHT	FERRULE CODE
		mm	mm	max. bar	min. mm	g/m	
PTFE1042	PTFE double metal braid 3/16"	4,8	9	365	30	130	BB1090
PTFE1062	PTFE double metal braid 1/4"	6,5	10,8	365	35	170	BB1091
PTFE1102	PTFE double metal braid 3/8"	9,7	14,4	285	50	260	BB1092
PTFE1122	PTFE double metal braid 1/2"	12,8	17,7	250	70	390	BBR26
PTFE1192	PTFE double metal braid 3/4"	19	24,2	200	180	630	on request
PTFE1252	PTFE double metal braid 1"	25,4	31,6	150	240	730	on request

**DOUBLE EXTERNAL METAL BRAID**

#### Technical-constructive features:

inner core in PTFE with double AISI 304 stainless steel reinforcement braid.

#### Application:

These hoses in PTFE have been created mainly for the high pressure conduction of paints, oils, air, food and steam. They do not dissipate electrostatic charges when conveying non-conductive fluids.

#### Working temperature:

From -60° C to +260° C From -76° F to +500° F

#### Specifications:

Reg. EU 1935/2004, Reg. EU 10/2011. Simulants A, B, C and D1. Standardised testing conditions OM6. Simulant D2 testing conditions OM7. FDA 21 CFR 177.1550  
Italian D.M. 174 of 06/04/2004 for use in drinking water supply chain.

# HOSES

## HIGH PRESSURE HOSES

### HP TWIN HOSE



Standard fitting NPS  
Fittings available: NPT - BSP - JIC



R7 TEXTILE BRAID HOSE x MATERIAL      POLYURETHANE HOSE x AIR

Demonstrative detail of the hose internal section.  
N.B: hose color may change depending on stock availability

CODE	DESCRIPTION	Ø I	Ø E	WORKING PRESSURE	RADIUS	WEIGHT	REEL*	FERRULE CODE
		mm	mm	max. bar	min. mm	g/m	mt	
6666660	HP material hose 3/16"	4,8	10	280	35	68	200	BB1090
	Hose for air	6	8	20	35	26	200	

\*An additional cost of €5 net per product will be applied for cutting the entire reel on request.

On request graphic customization of the suction system with a minimum quantity.

CODE	DESCRIPTION	MT	CONNECTION
6616500	HP twin hose 3/16"	mt 5	conn. 1/4"
6616750	HP twin hose 3/16"	mt 7,5	conn. 1/4"
6616100	HP twin hose 3/16"	mt 10	conn. 1/4"
6616150	HP twin hose 3/16"	mt 15	conn. 1/4"
6616200	HP twin hose 3/16"	mt 20	conn. 1/4"
<b>STEEL CONNECTION - Black material hose 3/16" - Press. max: 280 Bar (Psi 3960)</b>			
<b>STEEL CONNECTION - Blue hose for air 6x8mm - Press. max: 20 Bar (Psi 290)</b>			

#### R7 TEXTILE BRAID HOSE x MATERIAL

**Technical-constructive features:** inner core in polyamide, reinforcement in polyester fiber and exterior covering in micro-perforated abrasion resistant polyurethane for the air passage and compatible gases. These hoses are not able to disperse the electrostatic charges that can accumulate in the case of the passage of non-conductive fluids.

**Application:** these R7 textile braid hoses have been created for the high pressure conduction of polyols, solvents, paints and compatible gases.

**Working temperature:** from -40° C to +100° C  
From -40° F to +212° F  
Max. working temperature of air, water and water-based fluids is +95° C (+203° F).

**Vacuum rating:** 0,93 bar; 700 mm Hg

**Specifications:** meet or exceed SAE J517 sez. SAE 100R7 - ISO 3949 standards.

#### POLYURETHANE HOSE x AIR

**Technical-constructive features:** polyurethane's flexibility is comparable to rubber and has a good resistance to kinking.

**Application:** these tubes were created for the conduction of air, food fluids, breathable air; suitable for pneumatics.

**Working temperature:** from -20° C to +60° C.

**Specifications:** product in compliance with FDA 21 CFR 177.2600 regulation. Row material in compliance with UE 10/2011 regulation.

## LOW PRESSURE HOSES

### LP TWIN HOSE



Standard fitting NPS  
Fittings available: NPT - BSP - JIC



RILSAN HOSE x MATERIAL      POLYURETHANE HOSE x AIR

Demonstrative detail of the hose internal section.  
N.B: hose color may change depending on stock availability

CODE	DESCRIPTION	Ø I	Ø E	WORKING PRESSURE	RADIUS	WEIGHT	REEL*
		mm	mm	max. bar	min. mm	g/m	mt
6868680	HP material hose	6	8	9	35	26,8	100
	Hose for air	6	8	20	35	26	100

\*An additional cost of €5 net per product will be applied for cutting the entire reel on request.

On request graphic customization of the suction system with a minimum quantity.

CODE	DESCRIPTION	MT	CONNECTION
6668020	Twin hose 6x8mm	mt 2	conn. 1/4"
6668050	Twin hose 6x8mm	mt 5	conn. 1/4"
6668750	Twin hose 6x8mm	mt 7,5	conn. 1/4"
6668100	Twin hose 6x8mm	mt 10	conn. 1/4"
6668150	Twin hose 6x8mm	mt 15	conn. 1/4"
6668200	Twin hose 6x8mm	mt 20	conn. 1/4"

#### RILSAN HOSE x MATERIAL

**Technical-constructive features:** rilsan hose

**Application:** these hoses were created for the conduction of paints, oils, air, water-based fluids, foods, chemically aggressive fluids and steam.

**Working temperature:** from -40° C to +80° C.  
For water-based fluids operating temperature +70° C.

**Temperature peaks:** max +100° C.  
If the duration or frequency of the peaks is relevant, the service life of the pipe may be reduced.

**Specifications:** DIN 73378 - DIN 74324

#### POLYURETHANE HOSE x AIR

**Technical-constructive features:** polyurethane's flexibility is comparable to rubber and has a good resistance to kinking.

**Application:** these tubes were created for the conduction of air, food fluids, breathable air; suitable for pneumatics.

**Working temperature:** from -20° C to +60° C.

**Specifications:** product in compliance with FDA 21 CFR 177.2600 regulation. Row material in compliance with UE 10/2011 regulation.

# HOSES

## LOW PRESSURE HOSES

### RILSAN HOSE



Demonstrative detail of the hose internal section.  
N.B: hose color may change depending on stock availability

CODE	DESCRIPTION	Ø I	Ø E	WORKING PRESSURE	RADIUS	WEIGHT	REEL*
		mm	mm	max. bar	min. mm	g/m	mt
35024	Rilsan PA hose	2	4	67	20	9,8	100
35046	Rilsan PA hose	4	6	41	42	16,3	100
35068	Rilsan PA hose	6	8	27	65	22,9	100
35810	Rilsan PA hose	8	10	23	150	29,4	100
35112	Rilsan PA hose	10	12	27	120	51,4	100

\*An additional cost of €5 net per product will be applied for cutting the entire reel on request.

**Technical-constructive features:** rilsan hose

**Application:** these hoses were created for the conduction of paints, oils, air, water-based fluids, foods, chemically aggressive fluids and steam.

**Working temperature:** from -40° C to +80° C.  
For water-based fluids operating temperature +70° C.

**Temperature peaks:** max +100° C. If the duration or frequency of the peaks is relevant, the service life of the pipe may be reduced.

**Specifications:** DIN 73378 - DIN 74324

## LOW PRESSURE HOSES

### PU HOSE



Demonstrative detail of the hose internal section.  
N.B: hose color may change depending on stock availability

CODE	DESCRIPTION	Ø I	Ø E	WORKING PRESSURE	RADIUS	WEIGHT	REEL*
		mm	mm	max. bar	min. mm	g/m	mt
36024	PU hose	2	4	19	11	11,5	100
36046	PU hose	4	6	13	18	19,2	100
36068	PU hose	6	8	9	35	26,8	100
36810	PU hose	8	10	7	45	34,5	100

\*An additional cost of €5 net per product will be applied for cutting the entire reel on request.

**Technical-constructive features:** polyurethane's flexibility is comparable to rubber and has a good resistance to kinking.

**Application:** these tubes were created for the conduction of air, food fluids, breathable air; suitable for pneumatics.

**Working temperature:** from -20° C to +60° C.

**Specifications:** product in compliance with FDA 21 CFR 177.2600 regulation. Raw material in compliance with UE 10/2011 regulation.

# HOSES

## LOW PRESSURE HOSES

### RUBBER HOSE



CODE	DESCRIPTION	Ø I mm	Ø E mm	WORKING PRESSURE max. bar	RADIUS min. mm	WEIGHT g/m	REEL* mt
35200	Rubber hose	5	12	20	60	170	100
35250	Rubber hose	6	14	20	60	170	100
35300	Rubber hose	8	17	20	65	240	100
35400	Rubber hose	13	23	20	105	390	on request
35500	Rubber hose	19	30	20	150	580	on request

\*An additional cost of €5 net per product will be applied for cutting the entire reel on request.

#### Technical-constructive features:

Tube: black, seamless synthetic rubber compound.

Reinforcement: high strength synthetic fabrics.

Cover: black, abrasion, ageing, ozone and weather-resistant, seamless synthetic rubber compound.

#### Application:

delivery of compressed air, non-aggressive fluids and water for agricultural and industrial uses.

Working temperature: from -25° C to +80° C.

Specifications: ISO 8331

## LOW PRESSURE HOSES

### SOLVENT RESISTANT



CODE	DESCRIPTION	Ø I mm	Ø E mm	WORKING PRESSURE max. bar	RADIUS min. mm	WEIGHT g/m	REEL* mt
810170	Solvent resistant hose	10	17	10	60	170	100

\*An additional cost of €5 net per product will be applied for cutting the entire reel on request.

CODE	DESCRIPTION	MT	CONNECTION
810177	Solvent resistant hose	mt 7,5	conn. 3/8"
810171	Solvent resistant hose	mt 10	conn. 3/8"
810175	Solvent resistant hose	mt 15	conn. 3/8"

### STEEL CONNECTION

#### Technical-constructive features:

Tube: black, seamless synthetic rubber compound.

Reinforcement: high strength synthetic fabrics.

Cover: black, abrasion, ageing, ozone and weather-resistant, seamless synthetic rubber compound.

#### Application:

delivery of compressed air, non-aggressive fluids and water for agricultural and industrial uses.

Working temperature: from -40° C to +120° C.

Specifications: ISO 8331



## FITTINGS

*Berizzi supplies threaded fittings in different sizes, figures and materials, including accessories for hoses, guns and pumps, fittings, nuts, adapters, reductions, nipples, springs, extensions and couplings of high quality and resistance of various sizes.*



HIGH PRESSURE SWIVELS	page 240
FITTINGS FOR HP HOSES	page 244
ADAPTERS	page 246
DOUBLE CONNECTORS	page 248
LOW PRESSURE FITTINGS	page 250

# FITTINGS

## HP SWIVELS



CODE	DESCRIPTION
BB1090	Steel ferrule for HP1 hose 3/16"
BB1091	Steel ferrule for HP1 hose 1/4"
BB1092	Steel ferrule for HP1 hose 3/8"
BB1093	Steel ferrule for HP1 hose 1/2"
BB1094	Steel ferrule for HP1 hose 3/4"
BB1095	Steel ferrule for HP1 hose 1"
BB1096	Steel ferrule for HP2 hose 5/32"
BB1091D	Steel ferrule for HP2 hose 1/4"
BB1092D	Steel ferrule for HP2 hose 3/8"
BB1093D	Steel ferrule for HP2 hose 1/2"
BB1094D	Steel ferrule for HP2 hose 3/4"
BB1095D	Steel ferrule for HP2 hose 1"



CODE	DESCRIPTION
MOL316	Spring guard for hose 3/16"
MOL140	Spring guard for hose 1/4"
MOL380	Spring guard for hose 3/8"
MOL532	Spring guard for hose 5/32"
MOL516	Spring guard for hose 5/16"
MOL120	Spring guard for hose 1/2"



CODE	DESCRIPTION
BB1100	Nut FG 1/4" (BSP) swivel - Seal ball for hose 3/16" 90°
BB1101	Nut FG 1/4" (BSP) swivel - Seal ball for hose 1/4" 90°
BB1102	Nut F 3/8" (BSP) swivel - Seal ball for hose 1/4" 90°
BB1103	Nut F 3/8" (BSP) swivel - Seal ball for hose 3/8" 90°
BB1104	Nut F 1/2" (BSP) swivel - Seal ball for hose 1/2" 90°
BB1106	Nut F 3/4" (BSP) swivel - Seal ball for hose 3/4" 90°
BB1107	Nut F 3/4" (BSP) swivel - Seal ball for hose 1/2" 90°
BB1108	Nut F 1" (BSP) swivel - Seal ball for hose 1" 90°
BB1109	Nut F 1" (BSP) swivel - Seal ball for hose 3/4" 90°

### STEEL

CODE	DESCRIPTION
BB1100I	SSNut F 1/4" (BSP) swivel - Seal ball for hose 3/16" 90°
BB1101I	SSNut F 1/4" (BSP) swivel - Seal ball for hose 1/4" 90°
BB1102I	SSNut F 3/8" (BSP) swivel - Seal ball for hose 1/4" 90°
BB1103I	SSNut F 3/8" (BSP) swivel - Seal ball for hose 3/8" 90°
BB1104I	SSNut F 1/2" (BSP) swivel - Seal ball for hose 1/2" 90°
BB1106I	SSNut F 3/4" (BSP) swivel - Seal ball for hose 3/4" 90°
BB1108I	SSNut F 1" (BSP) swivel - Seal ball for hose 1" 90°

### STAINLESS STEEL

## HP SWIVELS



### STAINLESS STEEL

CODE	DESCRIPTION
BB1070I	SS Nut F 1/4" (BSP) swivel - Seal ball for hose 3/16"
BB1071I	SS Nut F 1/4" (BSP) swivel - Seal ball for hose 1/4"
BB1072I	SS Nut F 16x1,5mm swivel - Seal ball for hose 3/16"
BB1073I	SS Nut F 16x1,5mm swivel - Seal ball for hose 1/4"
BB1074I	SS Nut F 16x1,5mm swivel - Seal ball for hose 3/8"
BB1075I	SS Nut F 3/8" (BSP) swivel - Seal ball for hose 1/4"
BB1076I	SS Nut F 3/8" (BSP) swivel - Seal ball for hose 3/8"
BB1077I	SS Nut F 3/8" (BSP) swivel - Seal ball for hose 3/16"
BB1078I	SS Nut F 1/2" (BSP) swivel - Seal ball for hose 1/2"
BB1079I	SS Nut F 3/4" (BSP) swivel - Seal ball for hose 3/4"
BB1080I	SS Nut F 3/4" (BSP) swivel - Seal ball for hose 1/2"
BB1082I	SS Nut F 1" (BSP) swivel - Seal ball for hose 1"
BB1083I	SS Nut F 1" (BSP) swivel - Seal ball for hose 3/4"

CODE	DESCRIPTION
BB1070	Nut FG 1/4" (BSP) swivel - Seal ball for 3/16"
BB1071	Nut FG 1/4" (BSP) swivel - Seal ball for 1/4"
BB1084	Nut FG 1/4" (BSP) swivel - Seal ball for 3/8"
BB1072	Nut FG 16x1,5mm swivel - Steel seal ball for hose 3/16"
BB1073	Nut FG 16x1,5mm swivel - Steel seal ball for hose 1/4"
BB1074	Nut FG 16x1,5mm swivel - Steel seal for hose 3/8"
BB1075	Nut FG 3/8" (BSP) swivel - Steel seal ball for 1/4"
BB1076	Nut FG 3/8" (BSP) swivel - Steel seal ball for 3/8"
BB1077	Nut FG 3/8" (BSP) swivel - Steel seal ball for 3/16"
BB1085	Nut FG 3/8" (BSP) swivel - Steel seal ball for 1/2"
BB1078	Nut FG 1/2" (BSP) swivel - Steel seal ball for 1/2"
BB1086	Nut FG 1/2" (BSP) swivel - Steel seal ball for 3/8"
BB1079	Nut FG 3/4" (BSP) swivel - Steel seal ball for 3/4"
BB1080	Nut FG 3/4" (BSP) swivel - Steel seal ball for 1/2"
BB1082	Nut FG 1" (BSP) swivel - Steel seal ball for 1"
BB1083	Nut FG 1" (BSP) swivel - Steel seal ball for 3/4"
GE001	Nut F 1/4" (NPS) swivel - Steel seal ball for hose 3/16"
GE005	Nut F 1/4" (NPS) swivel - Steel seal ball for hose 1/4"
GE007	Nut F 1/2" JIC swivel - Steel seal ball for hose 3/16"
GE037	Nut F 1/2" JIC swivel - Steel seal ball for hose 1/4"
GE009	Nut F 3/8" (NPS) swivel - Steel seal ball for hose 3/8"
GE013	Nut F 1/4" (NPS) swivel - Steel seal ball for hose 5/32"
GE015	Nut F 16x1,5mm swivel - Steel seal ball for hose 5/32"



### STEEL



CODE	DESCRIPTION
GE002	Steel nut F 1/4" (NPS) swivel - SS seal ball for hose 3/16"
GE004	Steel nut F 16x1,5mm swivel - SS seal ball for hose 3/16"
GE006	Steel nut F 1/4" (NPS) swivel - SS seal ball for hose 1/4"
GE008	Steel nut F 16x1,5mm swivel - SS seal ball for hose 1/4"
GE010	Steel nut F 3/8" (NPS) swivel - SS seal ball for hose 3/8"
GE011	Steel nut F 3/8" (BSP) swivel - SS seal ball for hose 3/8"
GE012	Steel nut F 16x1,5mm swivel - SS seal ball for hose 3/8"
GE014	Steel nut F 1/4" (NPS) swivel - SS seal ball for hose 5/32"
GE016	Steel nut F 16x1,5mm swivel - SS seal Ball for hose 5/32"
GE018	Steel nut F 3/8" (BSP) swivel - SS seal Ball for hose 1/4"
GE020	Steel nut F 3/8" (BSP) swivel - SS seal ball for hose 3/16"
GE022	Steel nut F 1/4" (BSP) swivel - SS seal ball for hose 1/4"
GE024	Steel nut F 1/4" (BSP) swivel - SS seal ball for hose 3/16"
GE028	Steel nut F 3/4" (BSP) swivel - SS seal ball for hose 3/4"
GE026	Steel nut F 1/2" (BSP) swivel - SS seal ball for hose 1/2"
GE030	Steel nut F 1" (BSP) swivel - SS seal ball for hose 1"
GE032	Steel nut F 3/8" (NPS) swivel - SS seal ball for hose 5/32"
GE034	Steel nut F 3/8" (NPS) swivel - SS seal ball for hose 1/4"
GE036	Steel nut F 1/2 JIC swivel - SS seal ball for hose 1/4"
GE038	Steel nut F 1/2 JIC swivel - SS seal ball for hose 5/32"
GE040	Steel nut F 1/2 JIC swivel - SS seal ball for hose 3/16"

### STEEL NUT AND STAINLESS STEEL SEAL BALL



CODE	DESCRIPTION
BBS87	Rubber holder M 1/4" (NPS) for seal ball for hose Ø10
670001	Rubber holder M 1/4" (NPS) for seal ball for hose Ø8
BBS1843	Rubber holder M 1/4" (NPS) for seal ball for hose 5/32"
BBS1844	Rubber holder M 1/2" (JIC) for seal ball for hose 5/32"
BBS1717	Rubber holder M 1/4" (NPS) for seal ball for hose 3/16"
BBS1714	Rubber holder M 1/2" (JIC) for seal ball for hose 3/16"
BBS1715	Rubber holder M 1/4" (NPS) for seal ball for hose 1/4"
BBS1716	Rubber holder M 3/8" (NPS) for seal ball for hose 1/4"
BBS1620	Rubber holder M 1" (BSP) for seal ball for hose Ø25

### STAINLESS STEEL



CODE	DESCRIPTION
FR104SI	S. steel female hexagon 1/4" for 3/16" hose + steel ring nut
FR106SI	S. steel female hexagon 1/4" for 1/4" hose + steel ring nut
FR110SI	S. steel female hexagon 3/8" for 3/8" hose + steel ring nut

### STAINLESS STEEL



CODE	DESCRIPTION
FR104S	Female hexagon 1/4" for 3/16" hose + ring nut
FR105S	Female hexagon 1/4" for 5/32" hose + ring nut
FR106S	Female hexagon 1/4" for 1/4" hose + ring nut
FR138S	Female hexagon 3/8" for 1/4" hose + ring nut
FR110S	Female hexagon 3/8" for 3/8" hose + ring nut
FR112S	Female hexagon 1/2" for 1/2" hose + ring nut
FR116S	Female hexagon 16x1,5mm for 1/4" hose + ring nut
FR168S	Female hexagon 16x1,5mm for 3/8" hose + ring nut
FR107S	Female hexagon 1/2" JIC for 3/16" hose + ring nut
FR108S	Female hexagon 1/2" JIC for 1/4" hose + ring nut

### STEEL

CODE	DESCRIPTION
FR104S9	Female hexagon 1/4" for 3/16" hose 90° + ring nut
FR105S9	Female hexagon 1/4" for 5/32" hose 90° + ring nut
FR106S9	Female hexagon 1/4" for 1/4" hose 90° + ring nut
FR110S9	Female hexagon 3/8" for 3/8" hose 90° + ring nut
FR112S9	Female hexagon 1/2" for 1/2" hose 90° + ring nut
FR138S9	Female hexagon 3/8" for 1/4" hose 90° + ring nut
FR107S9	Female hexagon 1/2" JIC for 3/16" hose 90° + ring nut
FR108S9	Female hexagon 1/2" JIC for 1/4" hose 90° + ring nut
FR116S9	Female hexagon 16x1,5mm for 1/4" hose 90° + ring nut
FR168S9	Female hexagon 16x1,5mm for 3/8" hose 90° + ring nut

### STEEL

# FITTINGS

## FITTINGS FOR HP HOSES



CODE	DESCRIPTION
107000	SS swivel fitting M 1/4" NPS x M 14x1mm L.45mm
107001	SS swivel fitting M 3/8" NPS x M 14x1mm L.46mm
107004	SS swivel fitting M 1/4" BSP x M14x1mm L.45mm
107005	SS swivel fitting M16x1,5mm x M14x1mm L.47mm
107006	SS swivel fitting M 3/8" BSP x M14x1mm L.47mm
107007	SS swivel fitting M 1/2" JIC x M14x1mm L.47mm
107034	SS swivel fitting M 1/2" NPS x M14x1mm L.47mm

Max. pressure: 500 Bar / 7250 Psi in STAINLESS STEEL



CODE	DESCRIPTION
107002	SS swivel fitting M 16x1,5mm x M1/4" NPS L.47mm
107008	SS swivel fitting M 1/4" BSP x M 1/4" BSP L.44mm
107010	SS swivel fitting M 1/4" BSP x M 15x1mm L.44mm
107011	SS swivel fitting M 1/4" NPT x M 1/4" NPT L.45mm
107018	SS swivel fitting M 1/4" NPS x M 1/4" NPS L.44mm
107025	SS swivel fitting M1/4" BSP x M1/4" NPS L.42mm

Max. pressure: 500 Bar / 7250 Psi in STAINLESS STEEL



CODE	DESCRIPTION
107003	SS swivel fitting M16x1,5mm x F 1/4" NPS L.38mm
107009	SS swivel fitting M 1/4" BSP x F 1/4" BSP L.37mm
107012	SS swivel fitting M 1/4" NPT x F 1/4" NPT L.37mm
107013	SS swivel fitting M 1/4" BSP x F 1/4" NPS L.37mm
107015	SS swivel fitting M 1/4" NPT x F 1/4" NPS L.37mm
107016	SS swivel fitting M 3/8" NPT x F 1/4" NPS L.38mm
107017	SS swivel fitting M 1/4" NPS x F 1/4" NPS L.37mm
107019	SS swivel fitting M 3/8" NPS x F 1/4" NPS L.38mm
107020	SS swivel fitting M 3/8" BSP x F 3/8" BSP L.41mm
107021	SS swivel fitting M 3/8" BSP x F 1/4" BSP L.38mm
107022	SS swivel fitting M 1/4" NPS x F 1/4" BSP L.37mm
107023	SS swivel fitting M 1/4" NPS x F 3/8" NPS L.39mm
107024	SS swivel fitting M 3/8" NPS x F 3/8" NPS L.41mm
107026	SS swivel fitting M 1/4" NPS x F 16x1,5mm
107027	SS swivel fitting M 16x1,5mm x F 16x1,5mm
107030	SS swivel fitting M 16x1,5mm x F 1/4" BSP
107031	SS swivel fitting M 1/4" NPS x F1/2" JIC
107032	SS swivel fitting M 1/4" BSP x F1/2" JIC
107033	SS swivel fitting M 1/2" JIC x F1/2" JIC

Max. pressure: 500 Bar / 7250 Psi in STAINLESS STEEL

## FITTINGS FOR HP HOSES



CODE	DESCRIPTION
107014	Double swivel steel fitting M 1/4" NPS x F1/4" NPS
107038	Double swivel steel fitting M 3/8" NPS x F3/8" NPS

Max. pressure: 250 Bar / 3625 Psi in STEEL



CODE	DESCRIPTION
107028	Double swivel steel fitting M 1/4" NPS x M1/4" NPS
107029	Double swivel steel fitting M 3/8" NPS x M3/8" NPS

Max. pressure: 250 Bar / 3625 Psi in STEEL



CODE	DESCRIPTION
107014Z	Z swivel steel fitting M 1/4" NPS x F1/4" NPS
107038Z	Z swivel steel fitting M 3/8" NPS x F3/8" NPS

Max. pressure: 415 Bar / 6019 Psi in STEEL



CODE	DESCRIPTION
GR0114	Copper gasket 1/4"
GR0116	Copper gasket 16x1,5mm
GR0138	Copper gasket 3/8"
GR0112	Copper gasket 1/2"
GR0134	Copper gasket 3/4"
GR0110	Copper gasket 1"

## ADAPTERS



CODE	DESCRIPTION
161490	Adapter M x F 1/4" (BSP) x 1/4" (BSP) 90° swivel nut
163890	Adapter M x F 3/8" (BSP) x 3/8" (BSP) 90° swivel nut
161290	Adapter M x F 1/2" (BSP) x 1/2" (BSP) 90° swivel nut
163490	Adapter M x F 3/4" (BSP) x 3/4" (BSP) 90° swivel nut

### STEEL

CODE	DESCRIPTION
161490I	Stainless steel adapter M x F 1/4" (BSP) x 1/4" (BSP) 90° swivel nut
163890I	Stainless steel adapter M x F 3/8" (BSP) x 3/8" (BSP) 90° swivel nut

### STAINLESS STEEL

CODE	DESCRIPTION
161010	Adapter M x F 1" (BSP) swivel nut
161212	Adapter M x F 1/2" (BSP) swivel nut
161414	Adapter M x F 1/4" (BSP) swivel nut
161415	Adapter M x F 1/4" x 16x1,5mm swivel nut
161438	Adapter M x F 1/4" x 3/8" (BSP) swivel nut
161514	Adapter M x F 16x1,5mm x 1/4" (BSP)
161515	Adapter M x F 16x1,5mm swivel nut
161538	Adapter M x F 16x1,5mm x 3/8" swivel nut
163434	Adapter M x F 3/4" (BSP) swivel nut
163814	Adapter M x F 3/8" x 1/4" (BSP)
163815	Adapter M x F 3/8" x 16x1,5mm swivel nut
163838	Adapter M x F 3/8" (BSP) swivel nut
161412J	Adapter M x F 1/4" (BSP) x 1/2" JIC swivel nut

### STEEL

CODE	DESCRIPTION
161010I	Stainless steel adapter M x F 1" x 1" (BSP) swivel nut
161212I	Stainless steel adapter M x F 1/2" x 1/2" (BSP) swivel nut
161414I	Stainless steel adapter M x F 1/4" x 1/4" (BSP) swivel nut
161415I	Stainless steel adapter M x F 1/4" (BSP) x 16x1,5mm swivel nut
161438I	Stainless steel adapter M x F 1/4" x 3/8" (BSP) swivel nut
161514I	Stainless steel adapter M x F 16x1,5mm x 1/4" (BSP)
161515I	Stainless steel adapter M x F 16x1,5mm x 16x1,5mm swivel nut
161512I	Stainless steel adapter M x F 16x1,5mm x 1/2" (BSP) swivel nut
163434I	Stainless steel adapter M x F 3/4" x 3/4" (BSP) swivel nut
163814I	Stainless steel adapter M x F 3/8" x 1/4" (BSP) swivel nut
163815I	Stainless steel adapter M x F 3/8" x 16x1,5mm swivel nut
163838I	Stainless steel adapter M x F 3/8" x 3/8" (BSP) swivel nut
163812I	Stainless steel adapter M x F 3/8" x 1/2" (BSP) swivel nut

### STAINLESS STEEL



## ADAPTERS



STAINLESS STEEL CONNECTOR and STEEL NUT

CONNECTOR and NUT IN STEEL



CODE	DESCRIPTION
ADF002	SS adapter M 1/4" (NPS) x F 1/4" (BSP) swivel nut in steel
ADF004	SS adapter M 1/4" (BSP) x F 1/4" (NPS) swivel nut in steel
ADF006	SS adapter M 16x1,5mm x F 1/4" (NPS) swivel nut in steel
ADF008	SS adapter M 16x1,5mm x F 1/4" (BSP) swivel nut in steel
ADF010	SS adapter M 3/8" (NPS) x F 1/4" (NPS) swivel nut in steel
ADF012	SS adapter M 1/4" (NPS) x F 3/8" (NPS) swivel nut in steel
ADF014	SS adapter M 1/4" (NPS) x F 16x1,5mm swivel nut in steel
ADF016	SS adapter M 1/4" (BSP) x F 16x1,5mm swivel nut in steel
ADF018	SS adapter M 3/8" (NPS) x F 16x1,5mm swivel nut in steel
ADF020	SS adapter M 3/8" (BSP) x F 16x1,5mm swivel nut in steel
ADF022	SS adapter M 1/2" (NPS) x F 1/2" (NPS) swivel nut in steel
ADF024	SS adapter M 1/2" (NPS) x F 3/8" (NPS) swivel nut in steel
ADF026	SS adapter M 1/4" (NPS) x F 1/4" (NPS) swivel nut in steel
ADF027	SS adapter M 3/8" (BSP) x F 3/8" (NPS) swivel nut in steel
ADF028	SS adapter M 1/4" (NPT) x F 1/4" (NPS) swivel nut in steel

CODE	DESCRIPTION
ADF005	Steel adapter M 16x1,5mm x F 1/4" (NPS) swivel nut
ADF017	Steel adapter M 3/8" (NPS) x F 16x1,5mm swivel nut

CODE	DESCRIPTION
BBS1584	Stainless steel fix adapter F 1/4" x F 11/16"
BBS1585	Stainless steel fix adapter F 1/4" x M 1/2" JIC
BBS1585N	Stainless steel fix adapter F 1/4" (NPS) x M 1/2" JIC
BBS1586	Stainless steel fix adapter F 1/2" JIC x M 1/4"
BBS1586N	Stainless steel fix adapter F 1/2" JIC x M 1/4" (NPS)
BBS1587	Stainless steel fix adapter F 1/4" x M 3/8"
BBS1588	Stainless steel fix adapter F 3/8" x M 1/4"
BBS1595	Stainless steel fix adapter F 1/4" x M 16x1,5mm
BBS1595N	Stainless steel fix adapter F 1/4" (NPS) x M 16x1,5mm
BBS1596	Stainless steel fix adapter F 16x1,5 x M 1/4"

### STAINLESS STEEL

CODE	DESCRIPTION
NPS001	S. steel double connector M 1/4" NPS x M 1/4" NPS
NPS002	S. steel double connector M 1/4" NPS x M 3/8" NPS
NPS003	S. steel double connector M 3/8" NPS x M 3/8" NPS
NPS004	S. steel double connector M 1/4" NPS x M 1/2" NPS
NPS005	S. steel double connector M 3/8" NPS x M 1/2" NPS
NPS006	S. steel double connector M 1/2" NPS x M 1/2" NPS
NPS007	S. steel double connector M 3/8" NPS x M 16x1,5mm
NPS008	S. steel double connector M 16x1,5mm NPS x M 1/4" NPS

### NPS/ STAINLESS STEEL

CODE	DESCRIPTION
151010I	S. steel double connector M 1" x 1" BSP
151012I	S. steel double connector M 1" x M 1/2" BSP
151034I	S. steel double connector M 1" x M 3/4" BSP
151212I	S. steel double connector M 1/2" x 1/2" BSP
151238I	S. steel double connector M 1/2" x M 3/8" BSP
151412I	S. steel double connector M 1/2" x M 1/4" BSP
151414I	S. steel double connector M 1/4" x 1/4" BSP
151418I	S. steel double connector M 1/4" x M 1/8" BSP
151420I	S. steel double connector M 1/4" x M 20x2mm BSP
151514I	S. steel double connector M 16x1,5mm x M 1/4" BSP
151515I	S. steel double connector M 16x1,5mm x 16x1,5mm
151538I	S. steel double connector M 16x1,5mm x M 3/8" BSP
153412I	S. steel double connector M 3/4" x M 1/2" BSP
153414I	S. steel double connector M 3/4" x M 1/4" BSP
153434I	S. steel double connector M 3/4" x 3/4" BSP
153438I	S. steel double connector M 3/4" x M 3/8" BSP
153838I	S. steel double connector M 3/8" x 3/8" BSP
153814I	S. steel double connector M 3/8" x 1/4" BSP
151414CCI	S. steel double connector M 1/4" x 1/4" conical
151414CI	S. steel double connector 1/4" cylindrical x 1/4" conical

### BSP/ STAINLESS STEEL

CODE	DESCRIPTION
NPT001	S. steel double connector M 1/4" NPT x M 1/4" NPT
NPT002	S. steel double connector M 1/4" NPT x M 3/8" NPT
NPT003	S. steel double connector M 3/8" NPT x M 3/8" NPT
NPT004	S. steel double connector M 1/4" NPT x M 1/2" NPT
NPT005	S. steel double connector M 3/8" NPT x M 1/2" NPT
NPT006	S. steel double connector M 1/2" NPT x M 1/2" NPT

### NPT/ STAINLESS STEEL



CODE	DESCRIPTION
151212J	Steel double connector M 1/2" JIC x M 1/2" JIC
151412J	Steel double connector M 1/4" BSP x M 1/2" JIC
151212JI	Stainless steel double connector M 1/2" JIC x M 1/2" JIC
151412JI	Stainless steel double connector M 1/4" BSP x M 1/2" JIC
151412JNI	Stainless steel double connector M 1/2" JIC x M 1/2" JIC



CODE	DESCRIPTION
151010	Double connectors M 1" BSP x 1" BSP
151012	Double connectors M 1" BSP x 1/2" BSP
151034	Double connectors M 1" BSP x 3/4" BSP
151038	Double connectors M 1" BSP x 3/8" BSP
151212	Double connectors M 1/2" BSP x 1/2" BSP
151214	Double connectors M 1/2" BSP x 1/4" BSP
151238	Double connectors M 1/2" BSP x 3/8" BSP
151414	Double connectors M 1/4" BSP x 1/4" BSP
151420	Double connectors M 1/4" BSP x 20x2mm
151514	Double connectors M 16x1,5mm x 1/4"
151515	Double connectors M 16x1,5mm x 16x1,5mm
151538	Double connectors M 16x1,5mm x 3/8"
153412	Double connectors M 3/4" BSP x 1/2" BSP
153414	Double connectors M 3/4" BSP x 1/4" BSP
153434	Double connectors M 3/4" BSP x 3/4" BSP
153438	Double connectors M 3/4" BSP x 3/8"
153838	Double connectors M 3/8" BSP x 3/8" BSP
153814	Double connectors M 3/8" BSP x 1/4" BSP
FM61006	Double connectors M 3/4" BSP x 36x2mm
FM61066	Double connectors M 1/2" BSP x 36x2mm
151036	Double connectors M 1" x 36x2mm
151414C	Double connectors M 1/4" cylindrical x 1/4"

### BSP/ STEEL

CODE	DESCRIPTION
NPS003F	Steel double connector M16x1,5mm NPS x M 1/4" NPS

### NPS/ STEEL

# FITTINGS

## LOW PRESSURE FITTINGS



CODE	DESCRIPTION
41250	Quick coupling tap spiral 6x8mm
41300	Quick coupling tap spiral 8x10mm



CODE	DESCRIPTION
41425	Fixed bayonet joint spiral 6x8mm
41430	Fixed bayonet joint spiral 8x10mm



CODE	DESCRIPTION
41450	Fixed joint with spiral 6x8mm F 1/4"
41460	Fixed joint with spiral 8x10mm F 1/4"
41470	Revolved joint with spiral 6x8mm F 1/4"
41480	Revolved joint with spiral 8x10mm F 1/4"



CODE	DESCRIPTION
40010	Rubber holder bayonet joint 6 x14mm
40014	Rubber holder bayonet joint 8 x17mm
40015	Rubber holder bayonet joint 10x17mm
40016	Rubber holder bayonet joint 10x19mm



CODE	DESCRIPTION
41485	Quick coupling joint with spiral 6x8mm
41490	Quick coupling joint with spiral 8x10mm

## LOW PRESSURE FITTINGS



CODE	DESCRIPTION
41482	Spire joint with spiral 6 mm FG 1/4"



CODE	DESCRIPTION
40050	Quick coupling rubber holder 6x14mm
40060	Quick coupling rubber holder 8x17mm



CODE	DESCRIPTION
40070	Quick coupling adapter M 1/4"
40080	Quick coupling adapter M 3/8"
40100	Quick coupling adapter F 1/4"
40120	Quick coupling adapter F 3/8"
29041	Quick coupling adapter M 3/8" German



CODE	DESCRIPTION
41050	Bayonet joint M 1/4"
41055	Bayonet joint gasket



CODE	DESCRIPTION
40130	Bayonet quick coupling

# FITTINGS

## LOW PRESSURE FITTINGS



CODE	DESCRIPTION
41060	Millet nut F 1/4"
41062	Millet nut F 3/8"



CODE	DESCRIPTION
41100	Quick coupling tap M 1/4"
41110	Quick coupling tap M 3/8"
41150	Quick coupling tap F 1/4"
41160	Quick coupling tap F 3/8"



CODE	DESCRIPTION
41101	Double coupling with milled nut



CODE	DESCRIPTION
128618	Quick coupling connector 8/6mm M 1/8"
128614	Quick coupling connector 8/6mm M 1/4"
128638	Quick coupling connector 8/6mm M 1/4"
126414	Quick coupling connector 6/4mm M 1/4"
120814	Quick coupling connector 10/8mm M 1/4"
120838	Quick coupling connector 10/8mm M 3/8"
122138	Quick coupling connector 12/10mm M 3/8"
122112	Quick coupling connector 12/10mm M 1/2"



CODE	DESCRIPTION
27031	Air valve M 1/4" for milled nut M 1/4"
NG4010	Air valve M 1/8" for milled nut M 1/4"

## LOW PRESSURE FITTINGS



CODE	DESCRIPTION
129614	L quick coupling connector 6/4mm M 1/4" 90°
129818	L quick coupling connector 8/6mm M 1/8" 90°
129814	L quick coupling connector 8/6mm M 1/4" 90°
129838	L quick coupling connector 8/6mm M 3/8" 90°
129138	L quick coupling connector 10/8mm M 3/8" 90°
129238	L quick coupling connector 12/10mm M 3/8" 90°
129212	L quick coupling connector 12/10mm M 1/2" 90°



CODE	DESCRIPTION
40180	Joint with milled nut M 1/4"
40182	Joint with milled nut M 3/8"
40190	Joint with milled nut F 1/4"
40192	Joint with milled nut F 3/8"



CODE	DESCRIPTION
50800	Steel T fitting FFF 1/4"
50850	Steel T fitting FFF 3/8"



CODE	DESCRIPTION
41190	Rubber holder quick coupling tap 6x14mm
41200	Rubber holder quick coupling tap 8x17mm



CODE	DESCRIPTION
50680	Steel T fitting FMF 1/4"
50690	Steel T fitting FMF 3/8"



# FITTINGS

## LOW PRESSURE FITTINGS



CODE	DESCRIPTION
49500	Steel screw top M 1/8"
49505	Steel screw top M 1/4"
212428R	Steel screw top M 3/8"
49515	Steel screw top M 1/2"



CODE	DESCRIPTION
50600	Steel T fitting MFF 1/4"
50650	Steel T fitting MFF 3/8"



CODE	DESCRIPTION
50400	Steel L fitting MF 1/4"
50450	Steel L fitting MF 3/8"
50460	Steel L fitting MF 1/2"



CODE	DESCRIPTION
50500	Steel L fitting FF 1/4"
50550	Steel L fitting FF 3/8"
50560	Steel L fitting FF 1/2"



CODE	DESCRIPTION
46050	Steel nipple MM 1/8"
46060	Steel nipple MM 1/8" x 1/4"
46100	Steel nipple MM 1/4"
46300	Steel nipple MM 3/8"
46500	Steel nipple MM 1/2"
46200	Steel nipple MM 1/4" x 3/8"
46250	Steel nipple MM 1/4" x 1/2"
46400	Steel nipple MM 3/8" x 1/2"

## LOW PRESSURE FITTINGS



CODE	DESCRIPTION
47100	Steel reducer MF 1/4" x 1/8"
47200	Steel reducer MF 3/8" x 1/4"
47300	Steel reducer MF 1/2" x 1/4"
47400	Steel reducer MF 1/2" x 3/8"
47500	Steel reducer MF 3/8" x 1/8"



CODE	DESCRIPTION
48100	Steel extension FM 1/4" x 1/4"
48200	Steel extension FM 3/8" x 1/4"
48300	Steel extension FM 1/2" x 1/4"
48550	Steel extension FM 1/2" x 3/8"
48600	Steel extension FM 1/2" x 1/2"
48700	Steel extension FM 3/8" x 3/8"
48800	Steel extension FM 3/8" x 1/8"
48900	Steel extension FM 1/4" x 1/8"



CODE	DESCRIPTION
50050	Steel Y fitting FMF 1/8"
50100	Steel Y fitting FMF 1/4"
50150	Steel Y fitting FMF 3/8"



CODE	DESCRIPTION
50200	Steel Y fitting FFF 1/4"
50250	Steel Y fitting FFF 3/8"



CODE	DESCRIPTION
21504	Steel extension 42mm MF 1/8"
21507	Steel extension 50mm MF 1/4"

# FITTINGS

## LOW PRESSURE FITTINGS



CODE	DESCRIPTION
119405	Steel L automatic pipe connector 4 mm M 5 90°
119418	Steel L automatic pipe connector 4 mm M 1/8" 90°
119414	Steel L automatic pipe connector 4mm M 1/4" 90°
119618	Steel L automatic pipe connector 6mm M 1/8" 90°
119614	Steel L automatic pipe connector 6mm M 1/4" 90°
119818	Steel L automatic pipe connector 8mm M 1/8" 90°
119814	Steel L automatic pipe connector 8mm M 1/4" 90°
119838	Steel L automatic pipe connector 8mm M 3/8" 90°
119014	Steel L automatic pipe connector 10mm M 1/4" 90°
119038	Steel L automatic pipe connector 10mm M 3/8" 90°
119238	Steel L automatic pipe connector 12mm M 3/8" 90°
119212	Steel L automatic pipe connector 12mm M 1/2" 90°

## LOW PRESSURE FITTINGS



CODE	DESCRIPTION
45040	Stainless steel L connector FF 1/4"
45050	Stainless steel L connector FF 3/8"
45060	Stainless steel L connector FF 1/2"



CODE	DESCRIPTION
45100	Stainless steel L connector MF 1/4"
45110	Stainless steel L connector MF 3/8"
45120	Stainless steel L connector MF 1/2"



CODE	DESCRIPTION
110405	Steel automatic pipe connector 4mm M 5
110418	Steel automatic pipe connector 4mm M 1/8"
110414	Steel automatic pipe connector 4mm M 1/4"
110618	Steel automatic pipe connector 6mm M 1/8"
110614	Steel automatic pipe connector 6mm M 1/4"
110818	Steel automatic pipe connector 8mm M 1/8"
110814	Steel automatic pipe connector 8mm M 1/4"
110838	Steel automatic pipe connector 8mm M 3/8"
111014	Steel automatic pipe connector 10mm M 1/4"
111038	Steel automatic pipe connector 10mm M 3/8"
111238	Steel automatic pipe connector 12mm M 3/8"
111212	Steel automatic pipe connector 12mm M 1/2"



CODE	DESCRIPTION
45070	Stainless steel X connector FFFF 1/4"
45080	Stainless steel X connector FFFF 3/8"
45090	Stainless steel X connector FFFF 1/2"



CODE	DESCRIPTION
49100	Steel connector FF 1/8"
49200	Steel connector FF 1/4"
49300	Steel connector FF 3/8"
49400	Steel connector FF 1/2"



CODE	DESCRIPTION
45010	Stainless steel T connector FFF 1/4"
45020	Stainless steel T connector FFF 3/8"
45030	Stainless steel T connector FFF 1/2"

## SANDBLASTING

Berizzi supplies *sandblasting accessories* made of resistant materials: nozzles, fittings, pipes, nozzle holders, pneumatic remote control and more. They can be used for different uses and applications.

# SANDBLASTING



CODE	DESCRIPTION
UA601	Conical shutter 1" - 1/4"



CODE	DESCRIPTION
SX4000	SX nozzle 65mm
SX4001	SX nozzle 80mm
SX4002	SX nozzle 95mm
SX4003	SX nozzle 110mm
SX4004	SX nozzle 125mm



CODE	DESCRIPTION
OX400	OX nozzle holder 40mm red
OX500	OX nozzle holder 48mm blue



CODE	DESCRIPTION
OX0000	Rapid conical gasket
OX1040	Nylon rapid fitting 40mm
OX1048	Nylon rapid fitting 48mm
OX1054	Nylon rapid fitting 54mm
OX0010	Gasket for nylon rapid fitting



CODE	DESCRIPTION
OX4010	Steel rapid fitting 40mm
OX4810	Steel rapid fitting 48mm
OX5410	Steel rapid fitting 54mm
OX0010	Nylon gasket for nylon rapid fitting



CODE	DESCRIPTION
S609202	Steel rapid fitting 1" - 1/4"
OX0010	Nylon gasket for nylon rapid fitting
OX1010	Nylon rapid fitting 1" - 1/4"
S609200	Gasket for nylon rapid fitting



CODE	DESCRIPTION
S504211	Express coupling for rubber hose 13mm
S504212	Express coupling for rubber hose 16mm
S504213	Express coupling for rubber hose 19mm
S504214	Express coupling for rubber hose 25mm
S504215	Express coupling for rubber hose 32mm
S624205	Gasket for Express



CODE	DESCRIPTION
S506201	Pipe collar E22 - E29
S506202	Pipe collar E28 - E34
S506203	Pipe collar E32 - E40
S506204	Pipe collar E39 - E49
S506205	Pipe collar E48 - E60
S506206	Pipe collar E60 - E76
S624205	Gasket for Express

# SANDBLASTING



CODE	DESCRIPTION
S504201	Express coupling M 3/8"
S504202	Express coupling M 1/2"
S504203	Express coupling M 3/4"
S504204	Express coupling M 1"
S504205	Express coupling M 1" - 1/4"
S624205	Gasket for Express



CODE	DESCRIPTION
NOB1005	Sandblasting valve 1" - 1/4"



CODE	DESCRIPTION
S504206	Express coupling F 3/8"
S504207	Express coupling F 1/2"
S504208	Express coupling F 3/4"
S504209	Express coupling F 1"
S504210	Express coupling F 1" - 1/4"
S624205	Gasket for Express



CODE	DESCRIPTION
NOB2030	Pneumatic control
NOB2035	Silencer with fittings



CODE	DESCRIPTION
S809002	Sandblasting hose 25x40mm
S809004	Sandblasting hose 32x48mm

ROLL OF 40 mt



CODE	DESCRIPTION
NOB2000	Pneumatic control

## LOW PRESSURE SPRAY GUNS

*Berizzi distributes automatic and manual spray guns and lances for professional low-pressure paint spraying.*



MANUAL  
AUTOMATIC  
LANCES

page 266  
page 270  
page 271

# LOW PRESSURE SPRAY GUNS

## MANUAL - STAR



CODE	DESCRIPTION
AP110	Airbrush 0,2mm nozzle
AP112	Airbrush 0,3mm nozzle



### 106 T/J

CODE	DESCRIPTION
200603	Mini spray gun 106 T/J with nozzle 0,3mm
200605	Mini spray gun 106 T/J with nozzle 0,5mm
200608	Mini spray gun 106 T/J with nozzle 0,8mm
200610	Mini spray gun 106 T/J with nozzle 1mm
200612	Mini spray gun 106 T/J with nozzle 1,2mm
1130SE	Gravity cup 130cc Nylon upper
0006XX	Needle kit - aircap - nozzle



### SMV 4000

CODE	DESCRIPTION
SMV4112	Spray gun SMV 4000 with nozzle 1,2mm
SMV4114	Spray gun SMV 4000 with nozzle 1,4mm
SMV4116	Spray gun SMV 4000 with nozzle 1,6mm
SMV4118	Spray gun SMV 4000 with nozzle 1,8mm
SMV4120	Spray gun SMV 4000 with nozzle 2mm
SMV4125	Spray gun SMV 4000 with nozzle 2,5mm
SMV4130	Spray gun SMV 4000 with nozzle 3mm
BBS42XXK	Needle kit - aircap - nozzle SMV 4000
BBS40SE	Upper Gravity cup 600cc Nylon S4000 SMV

## MANUAL - STAR



### SMV 4000 SPECIAL

CODE	DESCRIPTION
SMV4112S	Spray gun SMV 4000 with nozzle 1,2mm SPECIAL
SMV4114S	Spray gun SMV 4000 with nozzle 1,4 mm SPECIAL
SMV4116S	Spray gun SMV 4000 with nozzle 1,6mm SPECIAL
SMV4118S	Spray gun SMV 4000 with nozzle 1,8mm SPECIAL
SMV4120S	Spray gun SMV 4000 with nozzle 2mm SPECIAL
SMV4125S	Spray gun SMV 4000 with nozzle 2,5mm SPECIAL
SMV4130S	Spray gun SMV 4000 with nozzle 3mm SPECIAL
BBS42XXK	Needle kit - aircap - nozzle SMV 4000
SER40SMVS	Under pressure upper tank SMV 4000



### S 710

CODE	DESCRIPTION
1071080	Spray gun S 710 SSP with nozzle 0,8mm
1071010	Spray gun S 710 SSP with nozzle 1mm
1071013	Spray gun S 710 SSP with nozzle 1,3mm
1071015	Spray gun S 710 SSP with nozzle 1,5mm
1071018	Spray gun S 710 SSP with nozzle 1,8mm
01710XXK	Needle kit - aircap - nozzle



### S 710

CODE	DESCRIPTION
1071110	Spray gun S 710 with cup 700cc 1mm
1071113	Spray gun S 710 with cup 700cc 1,3mm
1071115	Spray gun S 710 with cup 700cc 1,5mm
1071118	Spray gun S 710 with cup 700cc 1,8mm
71000SE	Lower tank 700cc Autoclave
107111	Cup gasket
107112	Drop saver
01710XXK	Needle kit - aircap - nozzle

# LOW PRESSURE SPRAY GUNS

## MANUAL - STAR

## MANUAL - STAR



### S 770

CODE	DESCRIPTION
1077015	Spray gun S 770 SSP with nozzle 1,5mm
1077017	Spray gun S 770 SSP with nozzle 1,7mm
1077020	Spray gun S 770 SSP with nozzle 2mm
1077025	Spray gun S 770 SSP with nozzle 2,5mm
01770XXK	Needle kit - aircap - nozzle



### SMV 1000

CODE	DESCRIPTION
SMV1113	Spray gun SMV 1000 with tank 700cc 1,3mm
SMV1115	Spray gun SMV 1000 with tank 700cc 1,5mm
SMV1118	Spray gun SMV 1000 with tank 700cc 1,8mm
BBS13XXK	Needle kit - aircap - nozzle SMV 1000
71000SE	Lower tank 700 cc Autoclave



### S 770

CODE	DESCRIPTION
1077117	Spray gun S 770 with cup 1000cc 1,7mm
1077120	Spray gun S 770 with cup 1000cc 2mm
1077125	Spray gun S 770 with cup 1000cc 2,5mm
77000SE	Lower tank 1000cc Autoclave
107711	Cup gasket
107712	Drop saver
01770XXK	Needle kit - aircap - nozzle



### SMV 2000

CODE	DESCRIPTION
SMV2012	Spray gun SMV 2000 with nozzle 1,2 mm
SMV2015	Spray gun SMV 2000 with nozzle 1,5mm
SMV2018	Spray gun SMV 2000 with nozzle 1,8mm
SMV2020	Spray gun SMV 2000 with nozzle 2mm
SMV2025	Spray gun SMV 2000 with nozzle 2,5mm
SMV2030	Spray gun SMV 2000 with nozzle 3mm
BBS23XXK	Needle kit - aircap - nozzle SMV 2000



### SMV 1000

CODE	DESCRIPTION
SMV1010	Spray gun SMV 1000 with nozzle 1mm
SMV1013	Spray gun SMV 1000 with nozzle 1,3mm
SMV1015	Spray gun SMV 1000 with nozzle 1,5mm
SMV1018	Spray gun SMV 1000 with nozzle 1,8mm
BBS13XXK	Needle kit - aircap - nozzle SMV 1000



### SMV 2000

CODE	DESCRIPTION
SMV2115	Spray gun SMV 2000 with cup 1000cc 1,5mm
SMV2118	Spray gun SMV 2000 with cup 1000cc 1,8mm
SMV2120	Spray gun SMV 2000 with cup 1000cc 2mm
SMV2125	Spray gun SMV 2000 with cup 1000cc 2,5mm
BBS23XXK	Needle kit - aircap - nozzle SMV 2000
77000SE	Lower tank 1000cc Autoclave



# LOW PRESSURE SPRAY GUNS

## AUTOMATIC - STAR

## LANCES



### S 710 AB

CODE	DESCRIPTION
107104AB	Automatic spray gun S 710AB with nozzle 0,4mm
107106AB	Automatic spray gun S 710AB with nozzle 0,6mm
107108AB	Automatic spray gun S 710AB with nozzle 0,8mm
107110AB	Automatic spray gun S 710AB with nozzle 1mm
107113AB	Automatic spray gun S 710AB with nozzle 1,3mm
0171XXABK	Needle kit - aircap - nozzle



### S 710 AD

CODE	DESCRIPTION
107104AD	Automatic spray gun S 710AD with nozzle 0,4mm
107106AD	Automatic spray gun S 710AD with nozzle 0,6mm
107108AD	Automatic spray gun S 710AD with nozzle 0,8mm
107110AD	Automatic spray gun S 710AD with nozzle 1mm
107113AD	Automatic spray gun S 710AD with nozzle 1,3mm
0171XXABK	Needle kit - aircap - nozzle



### SA-2C

CODE	DESCRIPTION
SA200010	Automatic spray gun SA-2C with nozzle 1mm
SA200012	Automatic spray gun SA-2C with nozzle 1,2mm
SA200015	Automatic spray gun SA-2C with nozzle 1,5mm
SA200018	Automatic spray gun SA-2C with nozzle 1,8mm
SA200020	Automatic spray gun SA-2C with nozzle 2mm
SA200025	Automatic spray gun SA-2C with nozzle 2,5mm
SA21KXX	Needle kit - aircap - nozzle SA-2C



### S 710 AA

CODE	DESCRIPTION
1071008A	Automatic spray gun S 710AA with nozzle 0,8mm
1071010A	Automatic spray gun S 710AA with nozzle 1mm
1071013A	Automatic spray gun S 710AA with nozzle 1,3mm
1071015A	Automatic spray gun S 710AA with nozzle 1,5mm
1071018A	Automatic spray gun S 710AA with nozzle 1,8mm
01710XXAK	Needle kit - aircap - nozzle



CODE	DESCRIPTION
TR78700	Manual spray lance



Spray lance for low pressure paint spraying suitable in the construction sector for medium-large surfaces, for all liquid and pasty products with a grain size of up to 2.5mm. Bear has an ON-OFF remote control that works through the valve of the lance. By opening or closing the gun valve it's possible to decide if activate or switch off the pump connected. It's suitable for Mistral pump and other peristaltic pumps from the main brands on the field.

CODE	DESCRIPTION
TT78600	Spray lance with remote control



Bear gun for low pressure paint spraying suitable in the construction sector for medium-large surfaces, for all liquid and pasty products with a grain size of up to 2.5mm. The gun has an ON-OFF remote control that works through the trigger of the lance. By opening or closing the gun valve it's possible to decide if activate or switch off the pump connected. It's suitable for Mistral pump and other peristaltic pumps from the main brands on the market.

CODE	DESCRIPTION
TT78650	Manual spray gun with remote control

### NOZZLES for LANCES for professional low-pressure paint spraying



CODE	DESCRIPTION
TR78625	Stainless steel flat nozzle
TR78624	Stainless steel nozzle Ø4,5
TR78623	Stainless steel nozzle Ø6,5
TR78622	Stainless steel nozzle Ø8,5
TR78621	Stainless steel nozzle Ø10,5

## HOSES SIZES TABLE

Ø INTERNAL INCH	Ø in DN-NW	Ø in mm
5/32"	DN-NW 4	4
3/16"	DN-NW 5	4,80
1/4"	DN-NW 6	6,40
5/16"	DN-NW 8	8
3/8"	DN-NW 10	9,60
1/2"	DN-NW 12	12,70
5/8"	DN-NW 16	15,90
3/4"	DN-NW 19	19,10
1"	DN-NW 25	25,40
1.1/4"	DN-NW 32	31,80
1.1/2"	DN-NW 38	38,10
2"	DN-NW 50	50,80
2.1/2"	DN-NW 63	63
3"	DN-NW 76	76

## SCREEN COMPARISON TABLE

MAGLIE	MICRON	MESH
64	900	20
144	600	30
225	450	40
400	350	50
500	275	60
800	230	75
1000	210	80
2000	160	100
2500	140	120
3000	120	130
5000	90	170
7000	80	200
8000	70	230
10000	60	250
15000	45	300
20000	35	350
27000	25	420
32000	20	460

The supplies of material made by Berizzi are governed exclusively by the following general sales conditions. Any clause or condition established by the client is null and void in our concerns, if the same has not been previously accepted by us in writing.

### 1. SALES AGREEMENT

The supplies of material made by Berizzi are governed exclusively by the following general sales conditions. Any clause or condition established by the client is null and void in our concerns, if the same has not been previously accepted by us in writing.

### 2. ORDERS

Delivery terms listed in our offers have to be considered, with the exclusion of sold items, always and in every way without our obligation. Orders are dispatched according to stock availability without warranty of balance. We do not accept orders with a total amount lower than **150,00€ transport excluded, except pumps**. If orders do not reach 150,00€, as described above, we will charge the difference in order to reach this amount.

### 3. ADDITIONS TO ORDERS

If customers send any goods addition with a total amount lower than 150,00€ (via e-mail/telephone) to an order in progress after receiving our order confirmation, Berizzi will charge 10,00€ for the order management and the shipment should be postponed to the following days.

### 4. PRICES

Prices of catalogue and price list are subject to change without notice. A packing cost may be applied to the products price (see point 5). If the price of raw materials or other items related to production should increase, we'll apply the corresponding increase without notice, through our order confirmation.

### 5. PACKAGING

In case of goods shipments using pallets, Berizzi applies a packing cost. This cost will vary according to the type of pallet used (fumigated/plastic or standard wood). For orders shipments with our courier, the packaging cost will be included in the transport costs indicated on the invoice. For shipments with a customer courier, a line related to the packaging cost will be included on the invoice.

### 6. PAYMENTS

All payments must be done in the terms and conditions agreed and mentioned on the invoice. In case of delayed payment, the defaulting customer must allow the interest on delayed payment, in compliance with the relevant provisions of the current D.L. 231/2002. In line with our policy, August and December deadlines are not postponed to the following month. Checks must be crossed out and made payable to Berizzi "NOT TRANSFERABLE" even if the check is delivered directly to our in charge. Discounts, allowances or rounding offs not previously agreed in writing are not accepted. Any claim doesn't entitle for suspension of payment. Berizzi is authorized to suspend the supply of any orders, until the full payment of overdue invoices.

### 7. GOODS AVAILABILITY

We inform you that, if a client wants to know the stock availability of our products, this information will not be given immediately over the phone, but please wait for a feedback by Berizzi staff via e-mail/telephone.

## NOTE:

### 8. SHIPMENTS

Goods always travels at risk of the buyer even if sold DDU. If customers don't indicate the name of the forwarder on the order, Berizzi will decide the most appropriate forwarder without assuming any responsibility. In case of advance payment, customers have two working days after receiving Berizzi's proforma to send the payment accountant. Goods availability will be guaranteed, unless otherwise communicated when sending the proforma, in this period of time. After this period, goods availability will no longer be guaranteed. Any lack of material will be communicated when sending the proforma.

### 9. GOODS IN-HOUSE PICK UP

Customers can proceed to pick up goods strictly after receiving notice of goods readiness from Berizzi staff. In case of pick up before the aforementioned communication, Berizzi will charge 20,00€ as "order management fees". This amount will also be charged in case of any order placed over the counter, addition to already confirmed and ready orders and/or immediate pick up urgencies.

### 10. REPAIR, RETURN and CLAIM

Berizzi accepts **goods returns** (repairs, defective goods, errors during the order phase, etc.) only with prior written agreement with our sales office. After authorizing the return, Berizzi staff will send the appropriate "return form" to fill in to complete the procedure. In case of special material, ordered or made on request, the return cannot be accepted. In case of customer errors, Berizzi will only accept goods returns purchased in the month in which the order was sent. After this period, no returns will be accepted due to order errors. Berizzi will accept returns due to customer order errors without applying costs for a maximum of three errors per year and always in relation to goods purchased in the month in which the order was sent. Starting from the fourth error, Berizzi will accept the return and charge 25% of the goods value (excluding VAT and transport).

For the realization of the estimate **repair quotation** of our products (pumps, spray guns, regulators, etc) a cost of 50,00€ will be charged. If the estimate is accepted and we proceed with the repair, the initial cost of 50,00€ will be removed.

**Claims** for missing or defective goods must be received in writing with all details (photo and description) within eight days from its arrival; after this date a fee may be charged.

### 11. WARRANTY

The judgment on the admissibility of warranty, for products deemed defective by the customer, it's only and unquestionably taken by Berizzi, only after checking the product. The misuse of the product, modifications, tampering, improper installation and unauthorized repairs will void the warranty.

### 12. RESPONSABILITY

Berizzi disclaims any responsibility arising from the use of equipment without compliance with the security requirements or not installed properly without carrying out checks of use and/or used outside the operating conditions specified by Berizzi.

### 13. PRIVACY

Pursuant to the legislation currently in force on the protection of personal data, the undersigned company informs that the personal data relating to its customers will be processed for the purposes necessary for the management of the customer/supplier relationship. Please consult our website [www.berizzi.it](http://www.berizzi.it) for a complete information on data processing.

### 14. DISPUTES

Any dispute is settled by the LECCO (Italy) court.

### WARNING:

ALL RIGHTS RESERVED. THE REPRODUCTION OF THIS PRICE LIST IS FORBIDDEN IN ANY FORM WITHOUT EXPRESS PERMIT WRITTEN BY BERIZZI.

R00 - 01/2024

*Made in Italy*

Via Torchio 10 - 24034 Cisano Bergamasco (BG) - Italia  
t. +39 0341 630184 - f. +39 0341 608707  
info@berizzi.it - [www.berizzi.it](http://www.berizzi.it)

